

# ***UNIMIG***



## ***CORE SERIES*** ***WELDING HELMET***

Operating Manual



**Core Series  
Welding Helmet - Black**

U21031



**Core Series  
Welding Helmet - Revenant**

U21032

## Contents

<b>1. Safety</b> .....	<b>3</b>
<b>2. Features</b> .....	<b>4</b>
<b>3. Specifications</b> .....	<b>5</b>
<b>4. Parts Breakdown</b> .....	<b>6</b>
<b>5. Operating Instructions</b> .....	<b>7</b>
<b>6. Harness Operating Instructions</b> .....	<b>12</b>
<b>7. Troubleshooting</b> .....	<b>14</b>
<b>8. Warranty</b> .....	<b>14</b>
<b>9. Shade Guide</b> .....	<b>15</b>

# 1. Safety

## **Please read and understand all instructions before using.**

- Be sure that the dark shade of the lens in the welding helmet is on the correct shade number for your application.
- The helmet and lenses are not suitable for “overhead” welding application, laser welding, or laser cutting applications.
- Welding helmets are designed to protect the eyes and face from sparks, spatter, and harmful radiation under normal welding conditions.
- This helmet will not protect against explosive devices or corrosive liquids. Machine guards or eye splash protection must be used when these hazards are present.
- Impact resistant, primary eye protection, spectacles or goggles that meet current ANSI specifications, must be worn at all times when using this welding helmet.
- Avoid work positions that could expose unprotected areas of the body to sparks, spatter, direct and/or reflected radiation. Use appropriate protection if exposure cannot be avoided.
- Before each use, check that the protection plates are clean and that no dirt is covering the sensors on the front of the lens.
- Inspect all operating parts before each use for signs of wear or damage. Any scratched, cracked, or pitted parts should be replaced immediately.
- Do not make any modifications to either the welding lens or helmet, other than those specified in this manual. Do not use any replacement parts other than those specified in this manual. Unauthorised modifications and replacement parts will void the warranty and expose the user to the risk of personal injury.
- If this lens does not darken when striking arc, stop welding immediately and check the helmet is in Weld Mode and not Grind Mode. If the issue persists, contact your local UNIMIG Service Department.
- Do not immerse this lens in water.
- Do not use any solvents on any lens or helmet components.
- The recommended operating temperature range for this welding lens is -5°C to 55°C. Do not use this device beyond these temperature limits.
- Failure to follow these warnings and/or failure to follow all of the operating instructions could result in severe personal injury.



**WARNING:** Contains button battery, hazardous if swallowed. Keep out of reach from children (whether the battery is new or used). Battery can cause severe or fatal injuries in 2 hours or less if it is swallowed or placed inside any part of the body. Medical attention should be sought immediately if it is suspected the battery has been swallowed or placed inside any part of the body.

## **2. Features**

### **98x48mm View Size**

Get clear visibility in every situation. The 98x48mm viewing area lets you see every weld with complete clarity.

### **External Grind Button**

Seamlessly switch to grind mode with the click of a button. When the helmet is in grind mode a small LED will illuminate, so you don't need to take the helmet off to check.

### **9-13 Shade Control**

Keep your eyes protected no matter the weld type. With a 9 to 13 shade range, you'll be covered while MIG, TIG or STICK welding, even when running as high as 500A.

### **4 Arc Sensors**

Detect every arc instantly. The four optimally positioned arc sensors trigger the lens, darkening it and keeping your eyes shielded from the start, even when you're out of position.

### **Backup Battery**

A CR2450 backup battery improves the performance and reliability of the auto-darkening filter.

### **4 Point Harness**

Get the perfect fit and stay comfortable for hours. Adjust all 4 points of contact to suit you, and have the weight spread more evenly, minimising neck strain.

### **EliteVision Lens Technology**

See your weld clearly in true colour. EliteVision technology allows more colours from the spectrum to pass through the view, giving you better optical clarity and reducing eye fatigue.

## 3. Specifications

### 3.1 Technical Data

Parameter	Values
Filter Dimensions	110x90x10mm
View Size	98x48mm
Arc Sensors	4
Classification	1/1/1/2
Light State	4
Dark State	9-13
UV/IR Protection	DIN15
Time from Light to Dark	0.1ms
Time from Dark to Light	0.1-0.8s
Sensitivity Delay	Adjustable
Power Supply	Solar Cells & CR2450 Replaceable Battery
Warranty	3 Years
Operating Temperature	-5°C to 55°C
Storage Temperature	-20°C to 55°C
Shade Control	Yes
Grind Mode	Yes (External)
Minimum TIG Amperage	10A
Standards	AS/NZS 1337.1 B (High Impact) AS/NZS 1338.1 (Auto-Darkening)

### 3.2 Replaceable Parts

Part	SKU
Core Series Welding Helmet Lens Kit	U21039
4 Point Harness	U21035
4 Point Harness Sweatband & Back Pad	U21036
Magnification Lens	U21010 - 1.5x Magnification Lens U21011 - 2.0x Magnification Lens U21012 - 2.5x Magnification Lens

## 4. Parts Breakdown

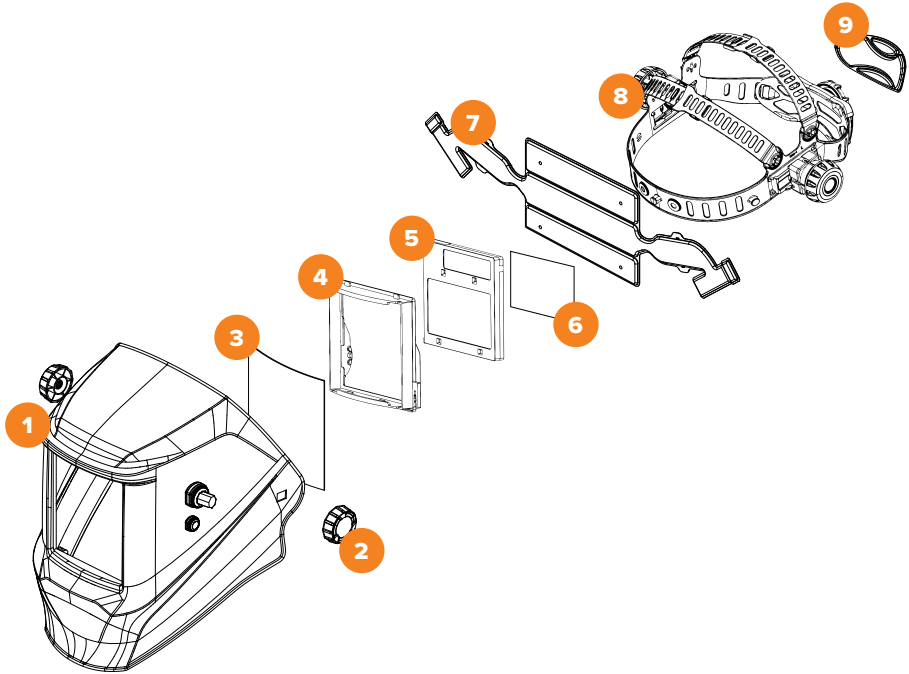

1. Helmet Shell
2. Adjustment Knob
3. Outer Lens Cover (U21037)
4. ADF Frame
5. Auto-Darkening Filter (ADF)
6. Inner Lens Cover (U21037)
7. 4 Point Harness Sweatband (U21036)
8. 4 Point Harness (U21035)
9. 4 Point Harness Back Pad (U21036)

## 5. Operating Instructions

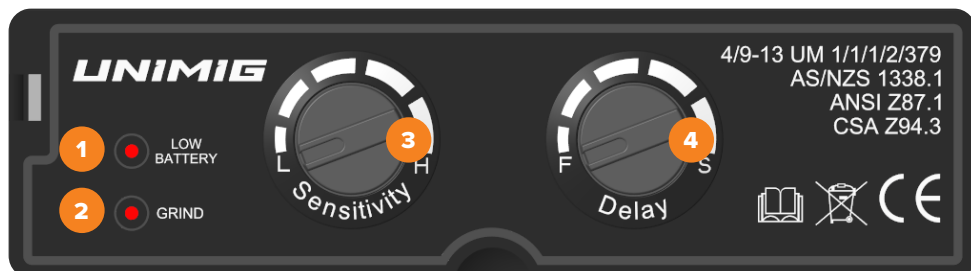

1. Low Battery Indicator
2. Grind Mode Indicator
3. Sensitivity Dial (Low to High)
4. Delay Dial (Fast to Slow)
5. Shade Selector Knob
6. Grind Mode Button



### Manual Shade Control

Choose your preferred shade by twisting the **Shade Selector Knob (5)** to the matching shade number (9-13).

#### Note:

Choose an optimum shade number for the required welding process or application.

If this lens does not darken when striking an arc, stop welding immediately and check the helmet is in Weld Mode and not Grind Mode. If the issue persists, contact your local UNIMIG Service Department.

## Sensitivity Control

The responsiveness to different light levels in various welding processes can be adjusted in the range from low to high.

Set the **Sensitivity Dial (3)** to your preferred level. Turn the dial **counter-clockwise** ↺ to decrease sensitivity, and rotate it **clockwise** ↻ to increase sensitivity.

### Low Sensitivity

- Suitable for high amperage welding and welding in bright light conditions (lamp light or sunlight).

### High Sensitivity

- Suitable for low amperage welding and use in poor light conditions.
- Suitable for use with steady arc process such as TIG welding.
- Under normal use, a higher sensitivity setting is recommended.

## Delay Control

The length of time delay for the ADF to return to the light state after welding can be adjusted in the range from fast to slow (0.1-0.9s). The time delay is for the protection of the welder's eyes from strong residual rays after welding.

Set the **Delay Dial (4)** to your preferred level. Turn the dial **counter-clockwise** ↺ to decrease delay time, and rotate it **clockwise** ↻ to increase delay time.

### Low Delay

- The time the ADF takes to lighten after welding becomes shorter. The shortest time is about 0.1s depending on the welding point temperature and shade setting. This setting is ideal for tack welding or production welding with short welds.

### High Delay

- The time the ADF takes to lighten after welding becomes longer. The longest time is about 0.8s depending on the welding point temperature and shade setting. This setting is ideal for welding at high amperage where there is an afterglow from the weld.

## Grind Mode

Press the **Grind Mode Button (6)** to initiate grind mode. Upon activation, the **Grind Mode Indicator (2)** light will begin to blink. To deactivate grind mode and revert back to weld mode, simply press the **Grind Mode Button (6)** again.

**Note: Do not weld in the grind mode, the ADF will not darken.**

## Low Battery Indicator

When the backup battery is low, the **Low Battery Indicator (1)** will begin to blink. Replace the battery when it is low, otherwise the ADF switching time will become slower, and shade accuracy will be compromised.

## Removing The ADF From The Helmet Shell

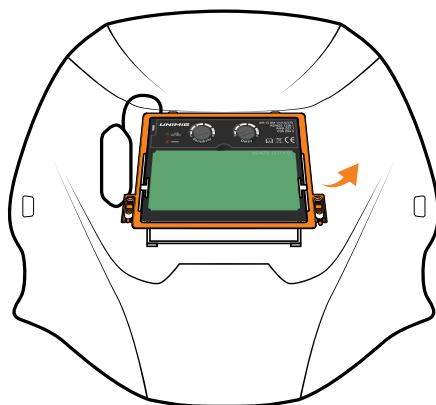
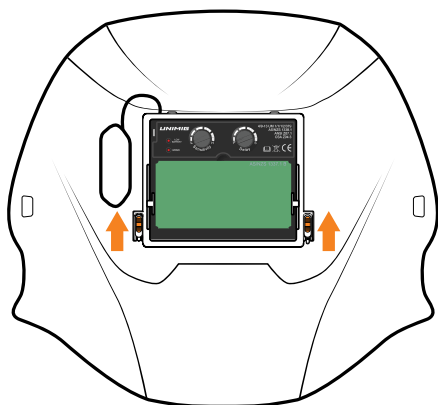

1. Switch both ADF frame locks to the up position to unlock it from the helmet shell.
2. Lift the bottom of the ADF up then slide the unit down to remove it from the helmet shell.

## Power Supply & Replacing The Battery

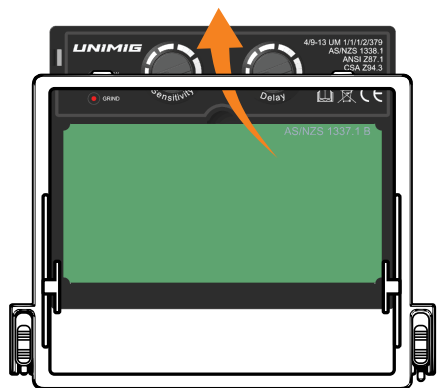

The power of the auto-darkening helmet is provided by solar cells and a CR2450 lithium battery. To change the battery, remove the ADF from the ADF frame. The battery compartment is on the top of the ADF, open the compartment to replace the battery.

## Changing The Inner Lens Cover

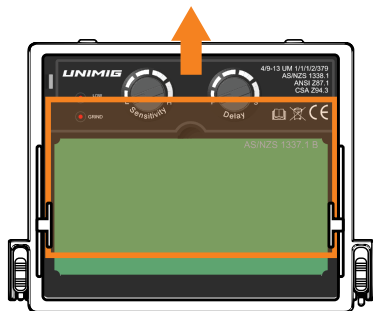

Pry the inner lens cover up from the finger groove at the top of the ADF. The inner lens cover can then slide up and out of the ADF. Replace with new inner lens cover.

## Changing The Outer Lens Cover

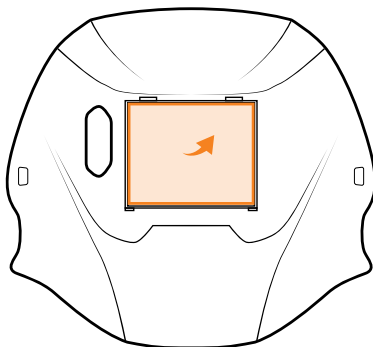

With the ADF frame removed, simply lift out the existing outer lens cover. Replace with new outer lens cover.

## Installing A Magnification Lens

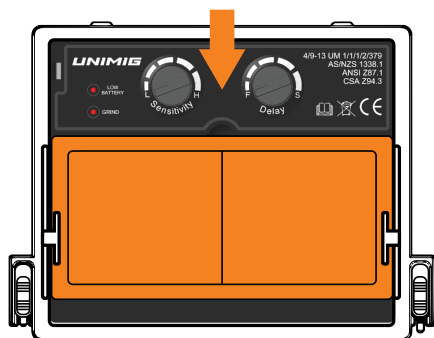

Slide the magnification lens down through the magnification lens holder.

## Additional Instructions

- Be sure that the helmet is used in the correct condition and according to the safety requirements.
- There is a liquid crystal-valve in the filter, although it has inner and outer protection covers, it is important to avoid heavy knocks to the helmet.
- The outer protective shell of the helmet should be periodically inspected and cleaned. In the case of a break, crack, pitting or other damage, the helmet shell must be replaced.
- To operate more efficiently and safely, please select the correct dark shade number.
- The arc light must be visible completely by all arc sensors. If not, the ADF may struggle to detect an arc and may not activate the selected shade.
- Please use the automatic filter at a temperature between -5°C-55°C.
- Do not disassemble the filter. If any problems arise, please contact your local UNIMIG service department.

## 6. Harness Operating Instructions

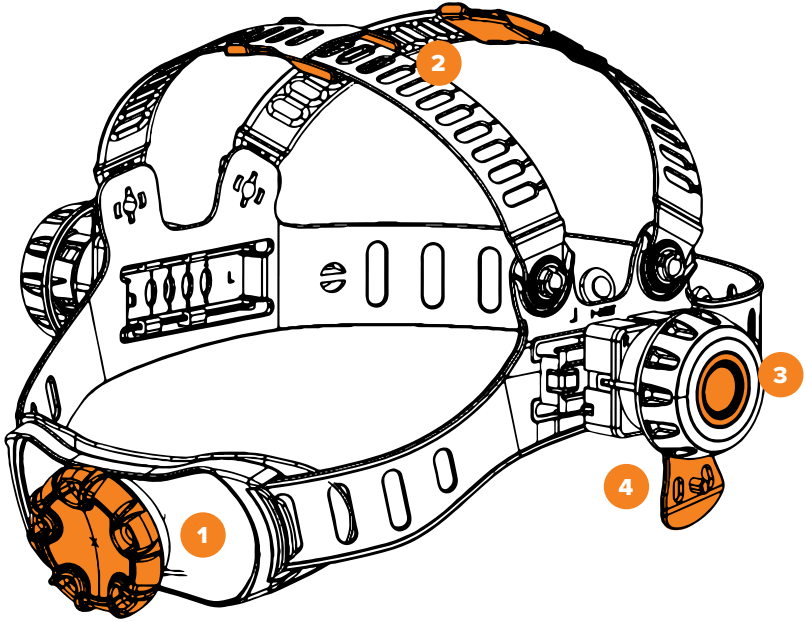

### 6.1 Neck Band Adjustment

To **tighten** the neck band, turn the neck band adjustment dial  clockwise .

To **loosen** the neck band, turn the neck band adjustment dial  anti-clockwise.

### 6.2 Head Strap Adjustment

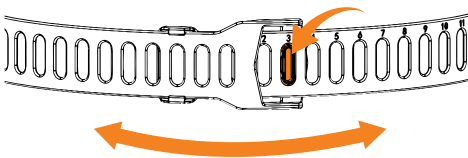

To adjust the head straps, first push the head strap lock out of the current position. Then adjust the strap to the desired length, and push the head strap lock into the corresponding position.

## 6.3 Distance Adjustment

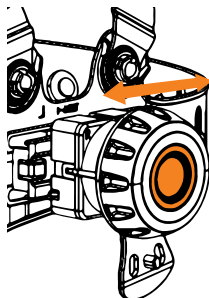

To adjust the distance between your face and the lens, push the distance adjuster buttons. The helmet shell can now move towards or away from your face. Release the buttons to lock the shell into position.

Ensure that both sides are equally positioned for proper vision.

## 6.4 Angle Adjustment

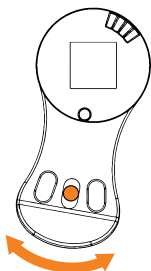

There are 3 positions available to set the angle of the helmet. To adjust, lift and reposition the locking tab into the desired angle position.

## **7. Troubleshooting**

### **1. The ADF does not darken when welding**

- Stop welding or cutting immediately.
- Make sure the sensors are facing the arc and there are no obstructions.
- Check the mode is on WELD, not GRIND.
- Review sensitivity recommendations and adjust sensitivity if possible.
- Replace the battery if necessary.

### **2. The ADF stays dark after welding or there is no arc present**

- Adjust the sensitivity to a lower level.
- If the worksite is too bright, it is recommended to reduce the surrounding light level.

### **3. The ADF switches during welding**

- Increase the sensitivity if possible.
- Make sure the sensors are facing the arc and there are no obstructions.
- Increasing Delay 0.1–0.3 seconds may also reduce switching.

## **8. Warranty**

UNIMIG auto-darkening welding helmets are covered for warranty for up to three years from the date of purchase from authorised UNIMIG dealers. The duration of use depends on various factors such as use, cleaning storage and maintenance. Frequent inspections are recommended.

## 9. Shade Guide

### MMA/STICK

Current	Shade
<40A	9
40-60A	10
60-175A	11
175-300A	12
300-500A	13
>500A	14

### TIG

Current	Shade
<20A	9
20-40A	10
40-100A	11
100-175A	12
175-250A	13
>250A	14

### MIG

Current	Shade
<100A	10
100-175A	11
175-300A	12
300-500A	13
>500A	14

### Arc Gouging

Current	Shade
<175A	10
175-225A	11
225-275A	12
275-350A	13
350-450A	14
>450A	15

### MAG

Current	Shade
<60A	10
60-125A	11
125-175A	12
175-300A	13
300-500A	14
>500A	15

### Plasma Cutting

Current	Shade
<150A	11
150-250A	12
>250A	13

# UNIMIG

B U I L T F O R W E L D E R S

[unimig.com.au](http://unimig.com.au)

    @UNIMIG

**HEAD OFFICE:**

112 Christina Rd,  
Villawood NSW 2163

PH: (02) 9780 4200  
FAX: (02) 9780 4210

E: [sales@unimig.com.au](mailto:sales@unimig.com.au)

**QLD OFFICE:**

19 Commerce Cct,  
Yatala QLD 4207

PH: (07) 3333 2855  
FAX: (07) 3274 5829

E: [qld@unimig.com.au](mailto:qld@unimig.com.au)

**VIC OFFICE:**

91 Yellowbox Drive,  
Craigieburn VIC 3064

PH: (03) 8682 9911  
FAX: (03) 9333 7867

E: [sales@unimig.com.au](mailto:sales@unimig.com.au)

**WA OFFICE:**

26 Sustainable Ave,  
Bibra Lake WA 6163

PH: (08) 6363 5111  
FAX: (08) 9417 4781

E: [wasales@unimig.com.au](mailto:wasales@unimig.com.au)