

UNIMIG

RazorWeld

MIG/STICK 200



OPERATING MANUAL

KUMJRRW200MIG



Please read and understand this instruction manual carefully before the installation and operation of this equipment.

© Welding Guns Of Australia PTY LTD 2018

WARRANTY

UNIMIG
RazorWeld

Thank you for your purchase of your UNIMIG RAZOR 200 Welding Machine.

We are proud of our range of plasma cutting and welding equipment that has a proven track record of innovation, performance and reliability.

Our product range represents the latest developments in Inverter technology put together by our professional team of highly skilled engineers. The expertise gained from our long involvement with inverter technology has proven to be invaluable towards the evolution and future development of our equipment range. This experience gives us the inside knowledge on what the arc characteristics, performance and interface between man and machine should be.

Within our team are specialist welders that have a proven history of welding knowledge and expertise, giving vital input towards ensuring that our machines deliver control and performance to the utmost professional level.

We employ an expert team of professional sales, marketing and technical personnel that provide us with market trends, market feedback and customer comments and requirements. Secondly they provide a customer support service that is second to none, thus ensuring our customers have confidence that they will be well satisfied both now and in the future.

UNIMIG welders and plasma cutters are manufactured to be compliant with - AS/NZ 60974-1, guaranteeing you electrical safety and performance.

WARRANTY

- 3 Years from date of purchase.
- Welding Guns Of Australia PTY LTD Ltd warranties all goods as specified by the manufacturer of those goods.
- This Warranty does not cover freight or goods that have been interfered with.
- All goods in question must be repaired by an authorised repair agent as appointed by this company.
- Warranty does not cover abuse, misuse, accident, theft, general wear and tear.
- New product will not be supplied unless Welding Guns Of Australia PTY LTD has inspected product returned for warranty and agrees to replace product.
- Product will only be replaced if repair is not possible
- Please view full Warranty term and conditions supplied with machine or at www.unimig.com.au/warranty-registration/ or at the back of this manual.

**REGISTER YOUR MACHINE ONLINE TO RECEIVE AN
ADDITIONAL 6 MONTHS ON YOUR WARRANTY**

Visit unimig.com.au/warranty-registration/ to register your machine.

CONTENTS



WARRANTY.....	2
SAFETY.....	4
RAZOR 200 TECHNICAL DATA.....	8
MACHINE PARTS LAYOUT.....	9
MIG WITH GAS INSTALLATION.....	11
GASLESS MIG INSTALLATION.....	13
WIRE FEED ROLLER SELECTION.....	15
WIRE INSTALLATION & SET UP GUIDE.....	16
MIG TORCH LINER INSTALLATION.....	17
TORCH & WIRE FEED SET UP FOR ALUMINIUM WIRE.....	18
MIG WELDING GUIDE.....	20
SPOOL GUN SETUP.....	26
MMA (STICK) WELDING SET UP.....	28
MMA (STICK) WELDING GUIDE.....	29
SB24 MIG TORCH & SPARES.....	31
MIG WELDING TROUBLE SHOOTING.....	33
MIG WIRE FEED TROUBLE SHOOTING.....	34
TIG WELDING TROUBLE SHOOTING.....	35
MMA (STICK) WELDING TROUBLE SHOOTING.....	36
SPARE PARTS IDENTIFICATION.....	37
WARRANTY TERMS.....	38

Welding and cutting equipment can be dangerous to both the operator and people in or near the surrounding working area, if the equipment is not correctly operated. Equipment must only be used under the strict and comprehensive observance of all relevant safety regulations.

Read and understand this instruction manual carefully before the installation and operation of this equipment.

Machine Operating Safety

- Do not switch the function modes while the machine is operating. Switching of the function modes during welding can damage the machine. Damage caused in this manner will not be covered under warranty.
- Disconnect the electrode-holder cable from the machine before switching on the machine, to avoid arcing should the electrode be in contact with the work piece.
- Operators should be trained and or qualified.



Electric shock: It can kill. Touching live electrical parts can cause fatal shocks or severe burns. The electrode and work circuit is electrically live whenever the output is on. The input power circuit and internal machine circuits are also live when power is on. In MIG/MAG welding, the wire, drive rollers, wire feed housing, and all metal parts touching the welding wire are electrically live. Incorrectly installed or improperly grounded equipment is dangerous.

- Connect the primary input cable according to Australian and New Zealand standards and regulations.
- Avoid all contact with live electrical parts of the welding/cutting circuit, electrodes and wires with bare hands.
- The operator must wear dry welding gloves while he/she performs the welding/cutting task.
- The operator should keep the work piece insulated from himself/herself.
- Keep cords dry, free of oil and grease, and protected from hot metal and sparks.
- Frequently inspect input power cable for wear and tear, replace the cable immediately if damaged, bare wiring is dangerous and can kill.
- Do not use damaged, under sized, or badly joined cables.
- Do not drape cables over your body.
- We recommend (RCD) safety switch is used with this equipment to detect any leakage of current to earth.



Fumes and gases are dangerous. Smoke and gas generated whilst welding or cutting can be harmful to people's health. Welding produces fumes and gases. Breathing these fumes and gases can be hazardous to your health.

Do not breathe the smoke and gas generated whilst welding or cutting, keep your head out of the fumes

- Keep the working area well ventilated, use fume extraction or ventilation to remove welding/cutting fumes and gases.
- In confined or heavy fume environments always wear an approved air-supplied respirator.
- Welding/cutting fumes and gases can displace air and lower the oxygen level causing injury or death. Be sure the breathing air is safe.
- Do not weld/cut in locations near de-greasing, cleaning, or spraying operations. The heat and rays of the arc can react with vapours to form highly toxic and irritating gases.
- Materials such as galvanized, lead, or cadmium plated steel, containing elements that can give off toxic fumes when welded/cut. Do not weld/cut these materials unless the area is very well ventilated, and or wearing an air supplied respirator.



Arc rays: harmful to people's eyes and skin. Arc rays from the welding/cutting process produce intense visible and invisible ultraviolet and infrared rays that can burn eyes and skin.

Always wear a welding helmet with correct shade of filter lens and suitable protective clothing including welding gloves whilst the welding/cutting operation is performed.

- Measures should be taken to protect people in or near the surrounding working area. Use protective screens or barriers to protect others from flash, glare and sparks; warn others not to watch the arc.



Fire hazard. Welding/cutting on closed containers, such as tanks, drums, or pipes, can cause them to explode. Flying sparks from the welding/cutting arc, hot work piece, and hot equipment can cause fires and burns. Accidental contact of electrode to metal objects can cause sparks, explosion, overheating, or fire. Check and be sure the area is safe before doing any welding/cutting.

- The welding/cutting sparks & spatter may cause fire, therefore remove any flammable materials well away from the working area. Cover flammable materials and containers with approved covers if unable to be moved from the welding/cutting area.
- Do not weld/cut on closed containers such as tanks, drums, or pipes, unless they are properly prepared according to the required Safety Standards to insure that flammable or toxic vapours and substances are totally removed, these can cause an explosion even though the vessel has been "cleaned". Vent hollow castings or containers before heating, cutting or welding. They may explode.
- Do not weld/cut where the atmosphere may contain flammable dust, gas, or liquid vapours (such as petrol)
- Have a fire extinguisher nearby and know how to use it. Be alert that welding/cutting sparks and hot materials from welding/cutting can easily go through small cracks and openings to adjacent areas. Be aware that welding/cutting on a ceiling, floor, bulkhead, or partition can cause fire on the hidden side.



Gas Cylinders. Shielding gas cylinders contain gas under high pressure. If damaged, a cylinder can explode. Because gas cylinders are normally part of the welding/cutting process, be sure to treat them carefully. CYLINDERS can explode if damaged.

- Protect gas cylinders from excessive heat, mechanical shocks, physical damage, slag, open flames, sparks, and arcs.
- Insure cylinders are held secure and upright to prevent tipping or falling over.
- Never allow the welding/cutting electrode or earth clamp to touch the gas cylinder, do not drape welding cables over the cylinder.
- Never weld/cut on a pressurised gas cylinder, it will explode and kill you.
- Open the cylinder valve slowly and turn your face away from the cylinder outlet valve and gas regulator.



Gas build up. The build up of gas can causes a toxic environment, deplete the oxygen content in the air resulting in death or injury. Many gases use in welding/cutting are invisible and odourless.

- Shut off shielding gas supply when not in use.
- Always ventilate confined spaces or use approved air-supplied respirator.



Electronic magnetic fields. MAGNETIC FIELDS can affect Implanted Medical Devices.

- Wearers of Pacemakers and other Implanted Medical Devices should keep away.
- Implanted Medical Device wearers should consult their doctor and the device manufacturer before going near any electric welding, cutting or heating operation.



Noise can damage hearing. Noise from some processes or equipment can damage hearing.

- Wear approved ear protection if noise level is high.



Hot parts. Items being welded/cut generate and hold high heat and can cause severe burns.

Do not touch hot parts with bare hands. Allow a cooling period before working on the welding/cutting gun. Use insulated welding gloves and clothing to handle hot parts and prevent burns.

CAUTION

1. Working Environment.

- i. The environment in which this welding/cutting equipment is installed must be free of grinding dust, corrosive chemicals, flammable gas or materials etc, and at no more than maximum of 80% humidity.
- ii. When using the machine outdoors protect the machine from direct sun light, rain water and snow etc; the temperature of working environment should be maintained within -10°C to +40°C.
- iii. Keep this equipment 30cm distant from the wall.
- iv. Ensure the working environment is well ventilated.

2. Safety Tips.

i. Ventilation

This equipment is small-sized, compact in structure, and of excellent performance in amperage output. The fan is used to dissipate heat generated by this equipment during the welding/cutting operation. Important: Maintain good ventilation of the louvres of this equipment. The minimum distance between this equipment and any other objects in or near the working area should be 30 cm. Good ventilation is of critical importance for the normal performance and service life of this equipment.

ii. Thermal Overload protection.

Should the machine be used to an excessive level, or in high temperature environment, poorly ventilated area or if the fan malfunctions the Thermal Overload Switch will be activated and the machine will cease to operate. Under this circumstance, leave the machine switched on to keep the built-in fan working to bring down the temperature inside the equipment. The machine will be ready for use again when the internal temperature reaches safe level.

iii. Over-Voltage Supply

Regarding the power supply voltage range of the machine, please refer to "Main parameter" table. This equipment is of automatic voltage compensation, which enables the maintaining of the voltage range within the given range. In case that the voltage of input power supply amperage exceeds the stipulated value, it is possible to cause damage to the components of this equipment. Please ensure your primary power supply is correct.

- iv. Do not come into contact with the output terminals while the machine is in operation. An electric shock may possibly occur.

MAINTENANCE

Exposure to extremely dusty, damp, or corrosive air is damaging to the welding/cutting machine. In order to prevent any possible failure or fault of this welding/cutting equipment, clean the dust at regular intervals with clean and dry compressed air of required pressure.

Please note that: lack of maintenance can result in the cancellation of the guarantee; the guarantee of this welding/cutting equipment will be void if the machine has been modified, attempt to take apart the machine or open the factory-made sealing of the machine without the consent of an authorized representative of the manufacturer.

TROUBLE SHOOTING

Caution: Only qualified technicians are authorized to undertake the repair of this welding/cutting equipment. For your safety and to avoid Electrical Shock, please observe all safety notes and precautions detailed in this manual.

ATTENTION! - CHECK FOR GAS LEAKAGE

At initial set up and at regular intervals we recommend to check for gas leakage

Recommended procedure is as follows:

1. Connect the regulator and gas hose assembly and tighten all connectors and clamps.
2. Slowly open the cylinder valve.
3. Set the flow rate on the regulator to approximately 8-10 L/min.
4. Close the cylinder valve and pay attention to the needle indicator of the contents pressure gauge on the regulator, if the needle drops away towards zero there is a gas leak. Sometimes a gas leak can be slow and to identify it will require leaving the gas pressure in the regulator and line for an extended time period. In this situation it is recommended to open the cylinder valve, set the flow rate to 8-10 L/min, close the cylinder valve and check after a minimum of 15 minutes.
5. If there is a gas loss then check all connectors and clamps for leakage by brushing or spraying with soapy water, bubbles will appear at the leakage point.
6. Tighten clamps or fittings to eliminate gas leakage.

IMPORTANT! - We strongly recommend that you check for gas leakage prior to operation of your machine. We recommend that you close the cylinder valve when the machine is not in use.

Welding Guns Of Australia PTY LTD, authorised representatives or agents of Welding Guns Of Australia PTY LTD will not be liable or responsible for the loss of any gas.

RAZOR 200 TECHNICAL DATA

MIG / STICK - 200 AMP INVERTER WELDER

Welds: Steels, Stainless, Cast Iron, Bronze, Aluminium, Copper

UNIMIG
RazorWeld



OVERVIEW

The RAZOR 200 MIG/STICK is an inverter-based portable MIG welding machine with added MMA function. The MIG function allows you to weld with both Gas Shielded and Gas-less wire applications. Easy step-less adjustment of voltage and wire feed make for easy setting of welding parameters giving excellent, professional welding results. Wire Inch gives easy feeding of the wire during set up without gas wastage and the Burn Back adjustment leaves the wire out ready for the next weld. MMA welding capability delivers easy electrode welding with high quality results, including cast Iron, stainless and low hydrogen.

An additional feature is the Spool Gun ready function that allows the simple connection of the PLSP240A Spool Gun for the use of thin or softer wires that don't have the column strength to feed through standard MIG torches, such as aluminium wire.

This is an industrial machine that is both lightweight and portable. Being 240v single phase gives great versatility. Ideal for general engineers, maintenance workshop and rural workshop, designed and built to our specification. Certified to - AS/NZ60974-1

MACHINE PACKAGE: KUMJRRW200MIG

- RAZOR 200 MIG/STICK Power Source
- SB24 Sure Grip MIG Torch (including consumables)
- 4m Twist Lock Electrode Holder
- 300 Amp Earth Clamp
- Twin Gauge Argon Regulator
- 2m Gas Hose Complete with fittings
- Operating Manual

TECHNICAL DATA - KUMJRRW200MIG

Power Supply / Phases (V-Ph)	240v - 1 +/- 15%
	20% @ 200 Amps MIG
	100% @ 89 Amps MIG
Duty Cycle @ 40°C as per AS/NZ60974-1	15% @ 200 Amps MMA
	100% @ 77 Amps MMA
Output Current Range	30A/15.5V - 200A/24.0V MIG
	10A/20.4V - 200A/28.0V MMA
Rated Power MIG (KVA)	9.4
I _{ieff}	15.0 Amps MIG
	15.0 Amps MMA
I _{Max}	33.6 Amps MIG
	39.0 Amps MMA
Power factor	0.70
Protection Class	IP21S
Insulation Class	F
Size (mm)	470x190x380mm
Weight (kg)	12.5 Kg

MACHINE PARTS LAYOUT

UNIMIG
RazorWeld

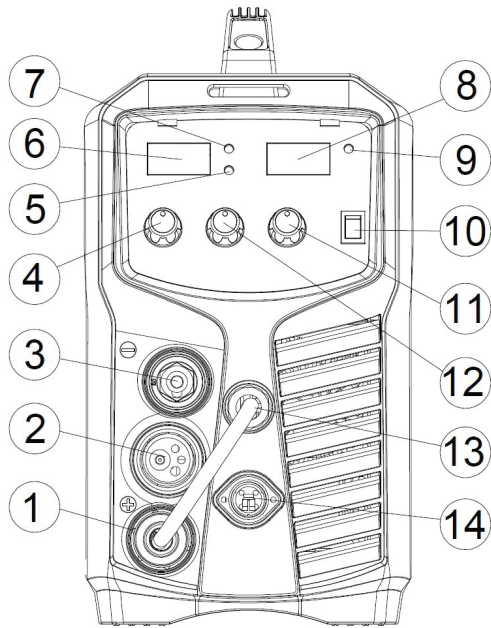

1. "+" output terminal
2. Euro connection
3. "-" output terminal
4. Current control knob in MMA
5. Thermal Overload LED
6. Current meter
7. Power LED
8. Voltage meter
9. VRD LED
10. MMA/TIG/MIG switch
11. Wire feed speed control in MIG
12. Voltage control knob in MIG
13. Gas/No gas switch
14. Socket for Spool Gun

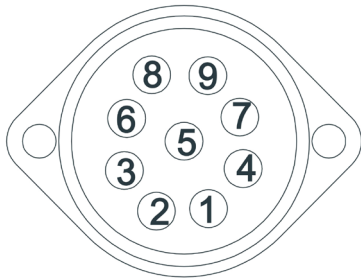

- Hole 1:** Spool Gun power source "-"
Hole 2: Spool Gun power source "+"
Hole 3~9: Null

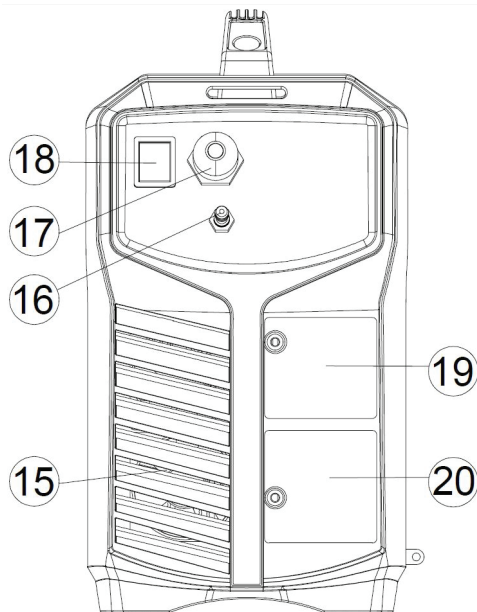

15. Fan
16. Gas inlet
17. Input power cord
18. Gas inlet
19. Warning mark
20. Rating plate

MACHINE PARTS LAYOUT

UNIMIG
RazorWeld

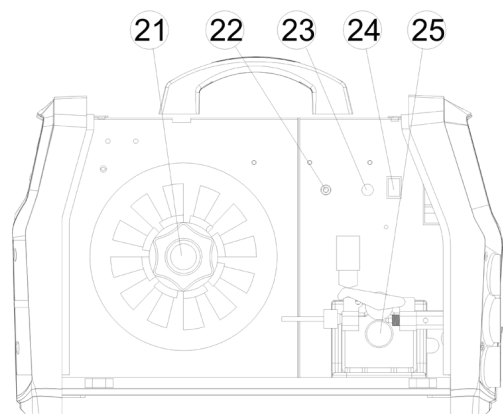

- 21. Wire feeding spindle
- 22. Burn-back control knob
- 23. Manual wire feeding button
- 24. Spool Gun selecting switch
- 25. Wire feeder

MIG WITH GAS INSTALLATION

UNIMIG
RazorWeld

1. Select the MIG function with the MIG/MMA selector switch.
2. Select **Standard** using the Standard/Spool Gun selector switch (Inside machine).
3. Connect the welding torch into the Euro Mig torch connection socket on the front panel, and tighten it.
4. Insert the earth cable plug into the required polarity and tighten - negative for gas shielded wires positive for gas less wires. The weld power cable goes into the opposing negative or positive socket.
5. Connect Gas Line to Gas Regulator and connect the gas regulator to the Gas Cylinder.
6. Fit the correct type and size of drive rollers
7. Place the Wire Spool onto the Spool Holder - Note: the spool retaining nut is Left Hand thread. Snip the wire from the spool being sure to hold the wire to prevent rapid uncoiling. Feed the wire into the wire feeder inlet guide tube through to the drive roller.
8. Carefully feed the wire over the drive roller into the outlet guide tube, feed through about 150mm into the torch receptacle. Check that the drive roller being used complies with the wire diameter, replace the roller if necessary.

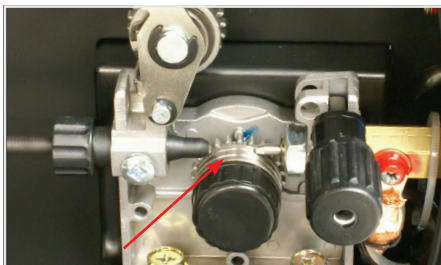

(6) Fit the correct type and size of drive rollers. V Groove for Hard Wires. U Groove for Aluminium. Knurled for Flux Cored

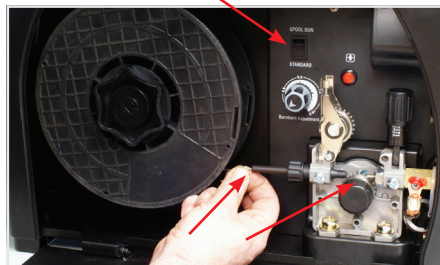

(7) Place wire onto spool holder - (spool retaining nut is left hand thread) Feed the wire through the inlet guide tube into the drive roller.

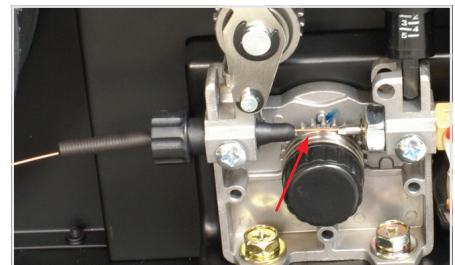

(8) Feed wire over the drive roller into the outlet guide tube, Push the wire through approx 150mm.

MIG WITH GAS INSTALLATION

UNIMIG
RazorWeld

9. Align the wire into the groove of the drive roller and close down the top roller making sure the wire is in the groove of the bottom drive roller, lock the pressure arm into place. Apply a medium amount of pressure to the drive roller.
10. Remove the gas nozzle and contact tip from the torch neck.
11. Press and hold the inch button to feed the wire through to the torch neck, release the inch button when the wire exits the torch neck.
12. Fit the correct sized contact tip and feed the wire through it, screw the contact tip into the tip holder of the torch head and nip it up tightly.
13. Fit the gas nozzle to the torch head.
14. Carefully open the gas cylinder valve and set the flow rate to between 5-10 l/min.
15. Set the welding parameters using the wire feed and voltage control knobs.
16. Using the Burn Back control set the amount of wire to 'burn back' after you release the torch trigger. This prevents the wire becoming stuck in the weld pool when finishing the weld.

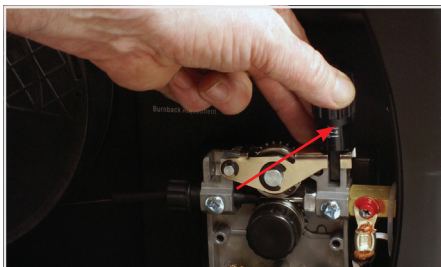

(9) Close down the top roller bracket and clip the pressure arm into place. Apply a medium amount of pressure to the drive roller

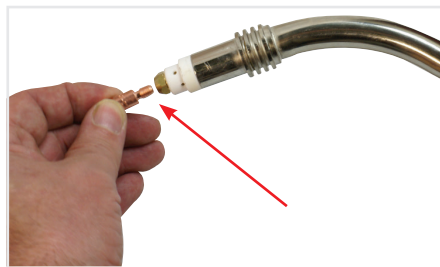

(10) Remove the gas nozzle and contact tip from the front end of the mig torch.



(11) Press and hold the inch wire button to feed the wire down the torch cable through to the torch head.



(12) Fit the correct size contact tip over the wire and fasten tightly into the tip holder.



(13) Fit the gas nozzle to the torch head.



(14) Carefully open the valve of the gas cylinder, set the flow to 5-10 l/min



(15) Set welding parameters using the voltage and wire feed controls.



(16) Adjust the burn back control to prevent the wire sticking in the weld pool. Burn back control is located above the wire feed motor

GASLESS MIG INSTALLATION

UNIMIG
RazorWeld

1. Select the MIG function with the MIG/MMA selector switch.
2. Select **Standard** using the Standard/Spool Gun selector switch (Inside machine).
3. Connect the weld power cable to the Negative socket and tighten it.
4. Connect the earth cable plug into the Positive socket and tighten it.
5. Connect the welding torch into the Euro Mig torch connection socket on the front panel, and tighten it.
IMPORTANT : When connecting the torch be sure to tighten the connection. A loose connection can result in the connector arcing and damaging the machine and gun connector. This damage is not covered under warranty.
6. Fit the correct size Knurled drive roller for Gas Less Flux Core wire.
7. Place the Wire Spool onto the Spool Holder - Note: the spool retaining nut is Left Hand thread. Snip the wire from the spool being sure to hold the wire to prevent rapid uncoiling. Feed the wire into the wire feeder inlet guide tube through to the drive roller.
8. Carefully feed the wire over the drive roller into the outlet guide tube, feed through about 150mm.

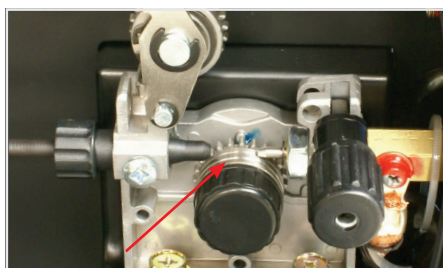

(6) Fit the correct size Knurled drive roller for Gas Less Flux Core wire

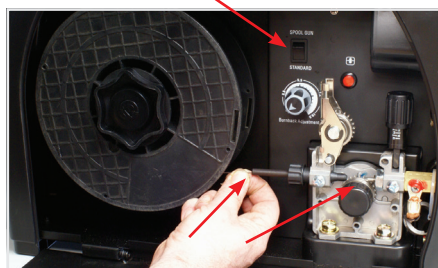

(7) Place wire onto spool holder - (spool retaining nut is left hand thread) Feed the wire through the inlet guide tube into the drive roller.

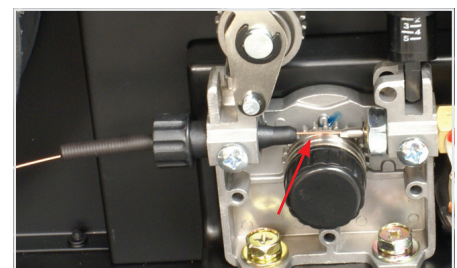

(8) Feed wire over the drive roller into the outlet guide tube, Push the wire through approx 150mm.

GASLESS MIG INSTALLATION

UNIMIG
RazorWeld

9. Align the wire into the groove of the drive roller and close down the top roller making sure the wire is in the groove of the bottom drive roller, lock the pressure arm into place
10. Apply a light amount of pressure to the drive roller. Too much pressure will crush the cored wire.
11. Remove the gas nozzle and contact tip from the torch neck,
12. Press and hold the inch button to feed the wire through to the torch neck, release the inch button when the wire exits the torch neck.
13. Fit the correct sized contact tip and feed the wire through it, screw the contact tip into the tip holder of the torch head and nip it up tightly.
14. Fit the gas nozzle to the torch head
15. Set the welding parameters using the wire feed and voltage control knobs.
16. Using the Burn Back control set the amount of wire to 'burn back' after you release the torch trigger. This prevents the wire becoming stuck in the weld pool when finishing the weld.

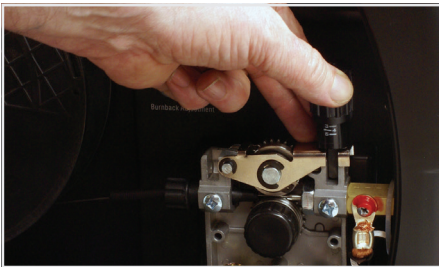

(9) Close down the top roller bracket and clip the pressure arm into place.

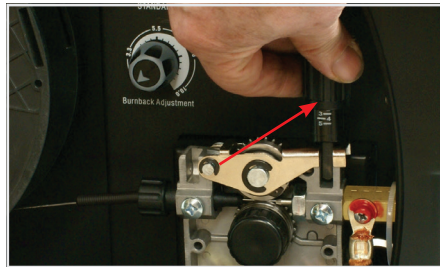

(10) Apply a medium amount of pressure to the drive roller

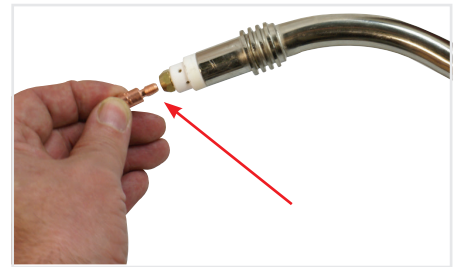

(11) Remove the gas nozzle and contact tip from the front end of the MIG torch.



(12) Press and hold the inch wire button to feed the wire down the torch cable through to the torch head.

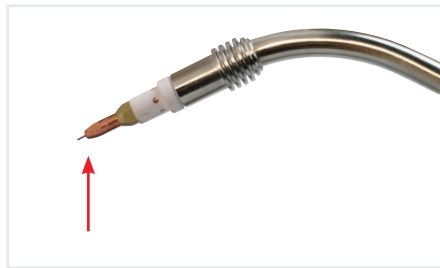

(13) Fit the correct size contact tip over the wire and fasten tightly into the tip holder.



(14) Fit the gas nozzle to the torch head.

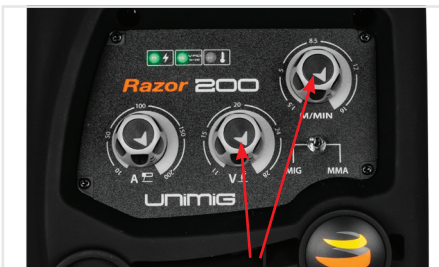

(15) Set welding parameters using the voltage and wire feed controls.



(16) Adjust the burn back control to prevent the wire sticking in the weld pool. Burn back control is located above the wire feed motor

WIRE FEED ROLLER SELECTION

The importance of smooth consistent wire feeding during MIG welding cannot be emphasized enough.

Simply put the smoother the wire feed then the better the welding will be.

Feed rollers or drive rollers are used to feed the wire mechanically along the length of the welding gun.

Feed rollers are designed to be used for certain types of welding wire and they have different types of grooves machined in them to accommodate the different types of wire. The wire is held in the groove by the top roller of the wire drive unit and is referred to as the pressure roller, pressure is applied by a tension arm that can be adjusted to increase or decrease the pressure as required. The type of wire will determine how much pressure can be applied and what type of drive roller is best suited to obtain optimum wire feed.

Solid Hard Wire - like Steel, Stainless Steel require a drive roller with a V shape groove for optimum grip and drive capability. Solid wires can have more tension applied to the wire from the top pressure roller that holds the wire in the groove and the V shape groove is more suited for this. Solid wires are more forgiving to feed due to their higher cross sectional column strength, they are stiffer and don't bend so easy.

Soft Wire - like Aluminium requires a U shape groove. Aluminium wire has a lot less column strength, can bend easily and is therefore more difficult to feed. Soft wires can easily buckle at the wire feeder where the wire is fed into inlet guide tube of the torch. The U-shaped roller offers more surface area grip and traction to help feed the softer wire. Softer wires also require less tension from the top pressure roller to avoid deforming the shape of the wire, too much tension will push the wire out of shape and cause it to catch in the contact tip.

Flux Core / Gasless Wire - these wires are made up of a thin metal sheath that has fluxing and metal compounds layered onto it and then rolled into a cylinder to form the finished wire. The wire cannot take too much pressure from the top roller as it can be crushed and deformed if too much pressure is applied. A knurled drive roller has been developed and it has small serrations in the groove, the serrations grip the wire and assist to drive it without too much pressure from the top roller. The down side to the knurled wire feed roller on flux cored wire is it will slowly over time bit by bit eat away at the surface of the welding wire, and these small pieces will eventually go down into the liner. This will cause clogging in the liner and added friction that will lead to welding wire feed problems. A U groove wire can also be used for flux core wire without the wire particles coming of the wire surface. However it is considered that the knurled roller will give a more positive feed of flux core wire without any deformation of the wire shape.

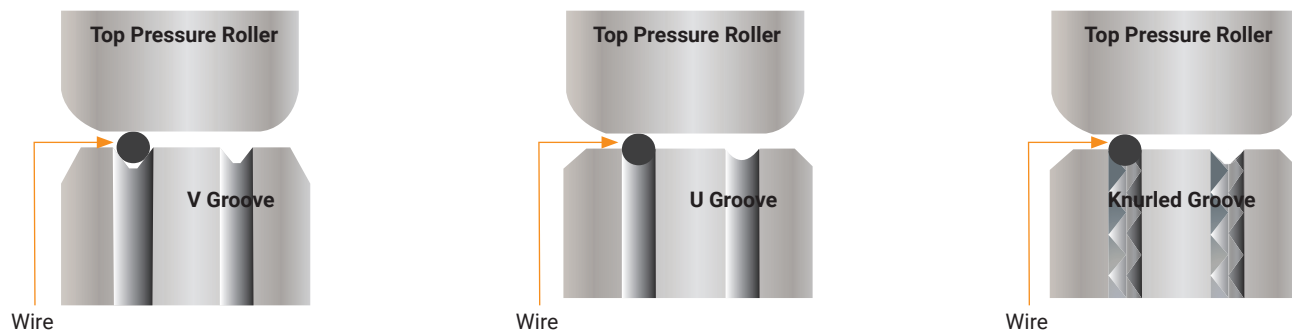

ROLLER DIAMETER: 30/22

V GROOVE DRIVE ROLLER - STEEL WIRE

Part-No	Description
0.6-0.8V30/22	Drive Roll V Groove 0.6-0.8mm
0.8-1.0V30/22	Drive Roll V Groove 0.8-1.0mm
0.9-1.2V30/22	Drive Roll V Groove 0.9-1.2mm
1.0-1.2V30/22	Drive Roll V Groove 1.0-1.2mm
1.2-1.6V30/22	Drive Roll V Groove 1.2-1.6mm

KNURLED DRIVE ROLLER - FLUX CORE WIRE

Part-No	Description
0.8-0.9F30/22	Drive Roll Knurled 0.8-0.9mm
0.9-1.2F30/22	Drive Roll Knurled 0.9-1.2mm
1.2-1.6F30/22	Drive Roll Knurled 1.2-1.6mm

U GROOVE DRIVE ROLLER - SOFT WIRE

Part-No	Description
0.8-1.0U30/22	Drive Roll U Groove 1.0-1.2mm
0.9-1.0U30/22	Drive Roll U Groove 0.9-1.0mm
0.9-1.2U30/22	Drive Roll U Groove 0.9-1.2mm
1.0-1.2U30/22	Drive Roll U Groove 1.0-1.2mm

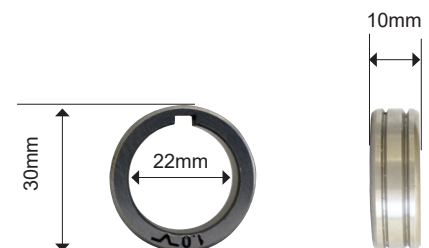

WIRE INSTALLATION & SET UP GUIDE

UNIMIG

RazorWeld

Again the importance of smooth consistent wire feeding during MIG welding cannot be emphasized enough.

The correct installation of the wire spool and the wire into the wire feed unit is critical to achieving an even and consistent wire feed. A high percentage of faults with MIG welders emanate from poor set up of the wire into the wire feeder. The guide below will assist in the correct setup of your wire feeder.



(1) Remove the spool retaining nut.

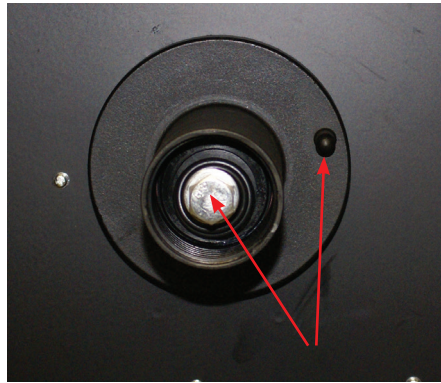

(2) Note the tension spring adjuster and spool locating pin.

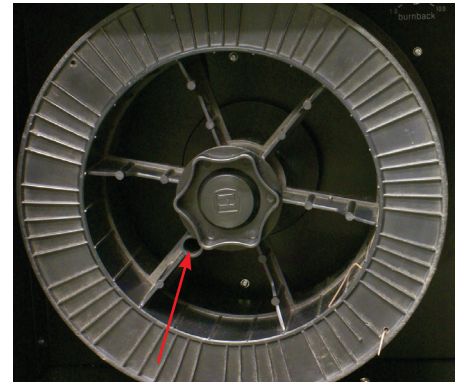

(3) Fit the wire spool onto the spool holder fitting the locating pin into the location hole on the spool. Replace the spool retaining nut tightly

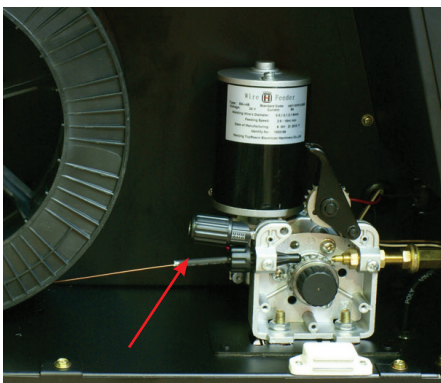

(4) Snip the wire carefully, be sure to hold the wire to prevent the spool uncoiling. Carefully feed the wire into the inlet guide tube of the wire feed unit.

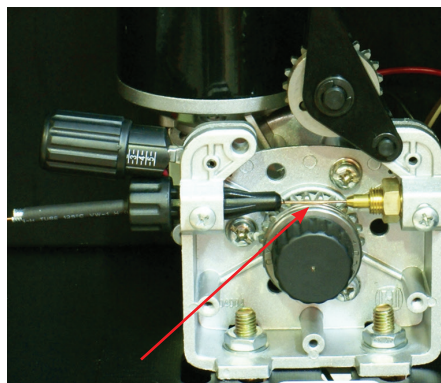

(5) Feed the wire through the drive roller and into the outlet guide tube of the wire feeder.

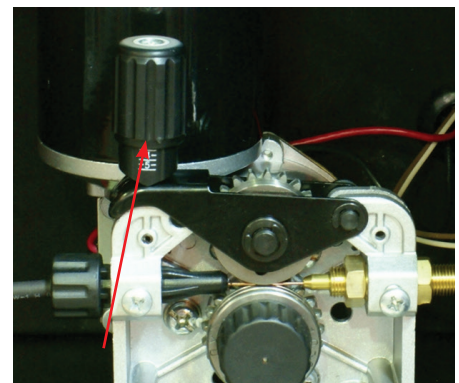

(6) Lock down the top pressure roller and apply a medium amount of pressure using the tension adjustment knob

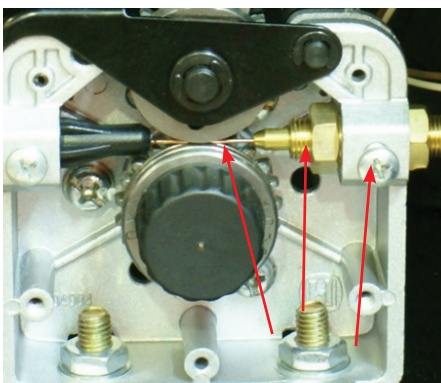

(7) Check that the wire passes through the centre of the outlet guide tube without touching the sides. Loosen the locking screw and then loosen the outlet guide tube retaining nut too make adjustment if required. Carefully re-tighten the locking nut and screw to hold the new position.



(8) A simple check for the correct drive tension is to bend the end of the wire over hold it about 100mm from your hand and let it run into your hand, it should coil round in your hand without stopping and slipping at the drive rollers, increase the tension if it slips.

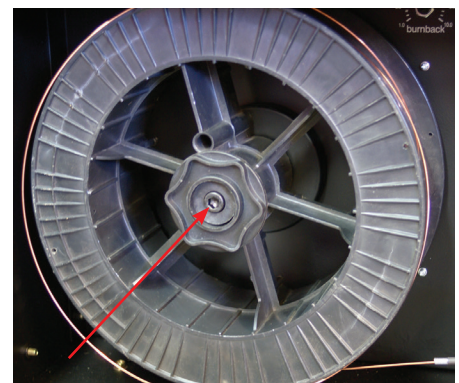

(9) The weight and speed of the wire spool turning creates an inertia that can cause the spool to run on and the wire loop over the side of the spool and tangle. If this happens increase the pressure on the tension spring inside the spool holder assembly using the tension adjustment screw.

MIG TORCH LINER INSTALLATION

UNIMIG
RazorWeld

1. Lay the torch out straight on the ground and remove the front end parts
2. Remove the liner retaining nut.
3. Carefully pull the liner out of the torch cable assembly
4. Select the correct new liner and carefully unravel avoiding putting any kinks in the liner, if you kink the liner it will make it no good and will require replacement.
5. Carefully and slowly feed the liner in short forward movements down the cable assembly all the way through and out the torch neck end. Avoid kinking the liner, kinking liner it will make it no good and require replacement.
6. Fit the liner retaining nut and screw down only 1/2 way
7. Leaving the torch straight snip the liner approximately 3mm past the end of the torch neck
8. Place the tip holder over the end of the liner and screw into the torch neck nipping it up tight.
9. Screw down the liner nut the remaining 1/2 and nip it up tight. This method compresses the liner inside the torch cable assembly preventing it moving during use and ensures good wire feed.



(1) Remove MIG torch front end parts

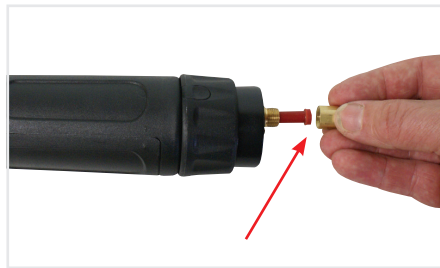

(2) Remove the liner retaining nut

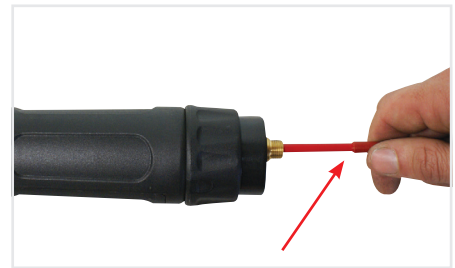

(3) Carefully pull out and completely remove the liner

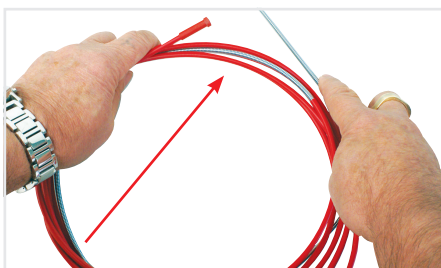

(4) Carefully unravel the new liner

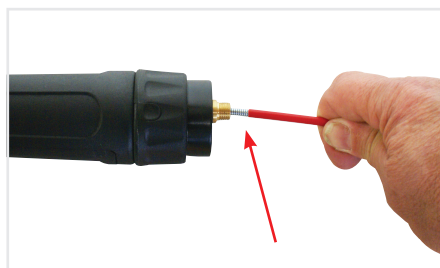

(5) Carefully feed in the new liner down the torch lead all the way to exit the torch neck.



(6) Fit the liner retaining nut and screw only 1/2 way down

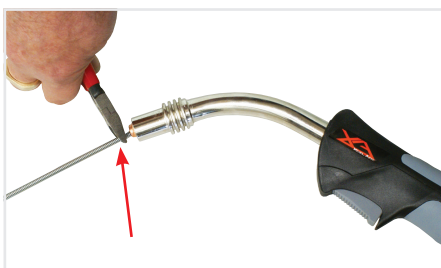

(7) Snip the liner off 3mm past the end of the torch neck.



(8) Replace the front end parts



(9) Fully screw down the liner retaining nut and nip it up tight.

TORCH & WIRE FEED SET UP FOR ALUMINIUM WIRE

UNIMIG
RazorWeld

1. Lay the torch out straight on the ground and remove the front end parts
2. Remove the liner retaining nut.
3. Carefully pull the liner out of the torch cable assembly
4. Select a Polymide or liner, carefully and slowly feed the liner in short forward movements down the cable assembly all the way through and out the torch neck end. Avoid kinking the liner, kinking the liner will ruin it and require replacement. Leave the liner extending out the end of the torch neck end by 3mm.
5. Fit the liner retaining nut together with the liner o-ring.
6. Replace the front end parts
7. Fit the liner collet, liner O-ring and liner retaining nut.
8. Push the liner firmly into the torch lead and tighten the liner retaining nut.
9. Install a U groove drive roller of the correct size to match the wire diameter being used.



(1) Remove MIG torch front end parts

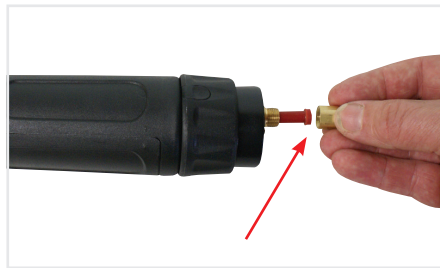

(2) Remove the liner retaining nut

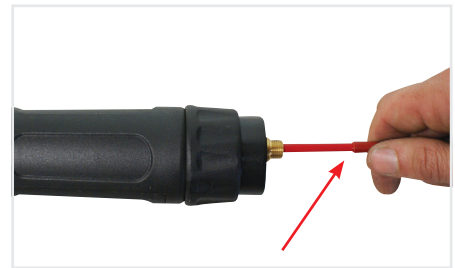

(3) Carefully pull out and completely remove the liner

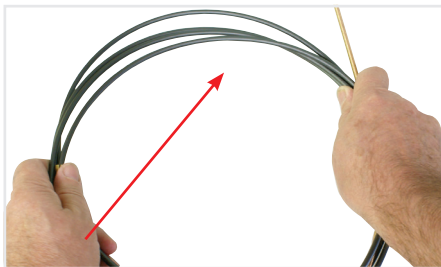

(4) Carefully unravel the new liner

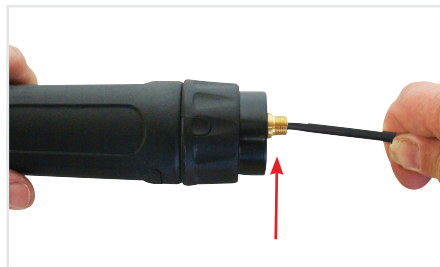

(5) Carefully feed in the new liner in short forward movements down the torch lead all the way to exit the torch neck. Be careful not to kink the liner



(6) Replace the front end parts

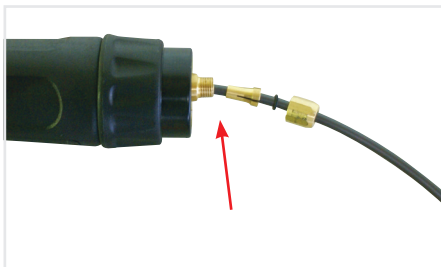

(7) Fit the liner collet, liner O-ring and liner retaining nut.

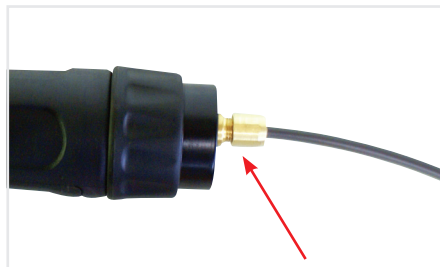

(8) Push the liner firmly into the torch lead and tighten the liner retaining nut

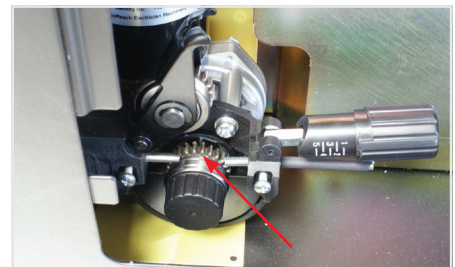

(9) Install a U groove drive roller of the correct size for the diameter wire being used.

TORCH & WIRE FEED SET UP FOR ALUMINIUM WIRE

UNIMIG
RazorWeld

10. Loosen off the inlet guide tube retaining screw
11. Remove the inlet guide tube from the front end machine Euro connector using long nose pliers.
12. Carefully feed the extended Polymide liner section into the inlet guide tube hole of the machine Euro connector
13. Feed the extended Polymide liner all the way up and over the drive roller
14. Tighten the torch Euro connection to the machine Euro connector
15. Cut the extended liner with a sharp Stanley knife just in front of the drive roller
16. Fit an Aluminium contact tip of the correct size to match the diameter of the wire being used
17. Fit the remaining front end parts to the torch neck ready for welding

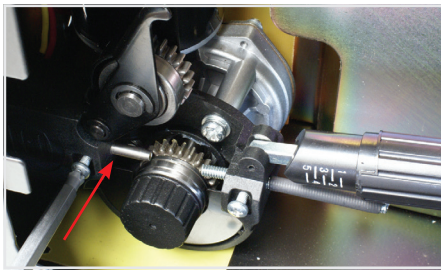

(10) Loosen the inlet guide tube retaining screw.

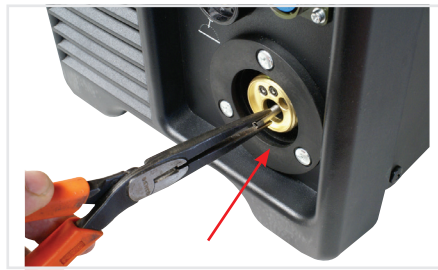

(11) Remove the inlet guide tube using long nose pliers.

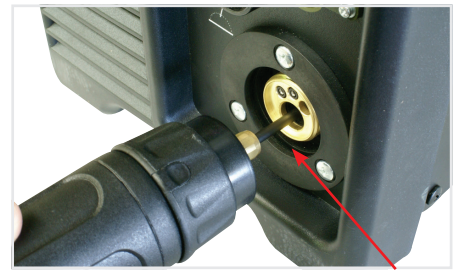

(12) Carefully feed the Polymide liner into the inlet guide tube hole of the torch Euro receptacle

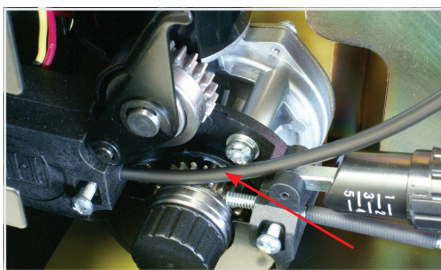

(13) Take the extended Polymide liner all the way up and over the drive roller

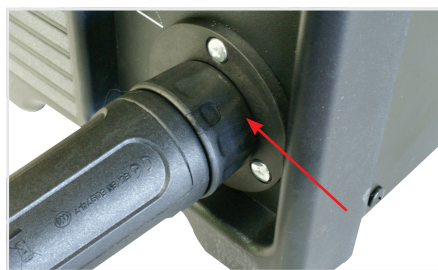

(14) Tighten and secure the torch Euro connector to the machine Euro receptacle

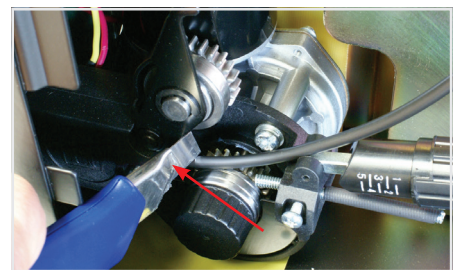

(15) Cut the extended Polymide liner with a sharp Stanley knife just in front of the drive roller

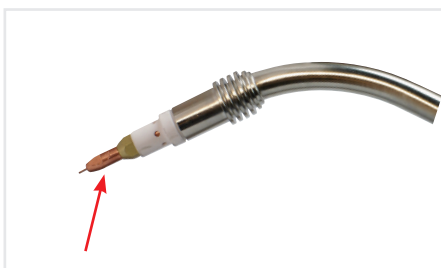

(16) Fit an Aluminium contact tip of the correct size to match the wire diameter being used



(17) Fit the remaining front end parts to the torch neck ready for welding.

MIG (Metal Inert Gas) Welding

Definition of MIG Welding - MIG (metal inert gas) welding also known as GMAW (gas metal arc welding) or MAG (metal active gas welding), is a semi-automatic or automatic arc welding process in which a continuous and consumable wire electrode and a shielding gas are fed through a welding gun. A constant voltage, direct current power source is most commonly used with MIG welding. There are four primary methods of metal transfer in MIG welding, called short circuit (also known as dip transfer) globular transfer, spray transfer and pulsed-spray, each of which has distinct properties and corresponding advantages and limitations. To perform MIG welding, the basic necessary equipment is a welding gun, a wire feed unit, a welding power supply, an electrode wire, and a shielding gas supply. Short circuit transfer is the most common used method whereby the wire electrode is fed continuously down the welding torch through to and exiting the contact tip. The wire touches the work piece and causes a short circuit the wire heats up and begins to form a molten bead, the bead separates from the end of the wire and forms a droplet that is transferred into the weld pool. This process is repeated about 100 times per second, making the arc appear constant to the human eye.

MIG Circuit Diagram

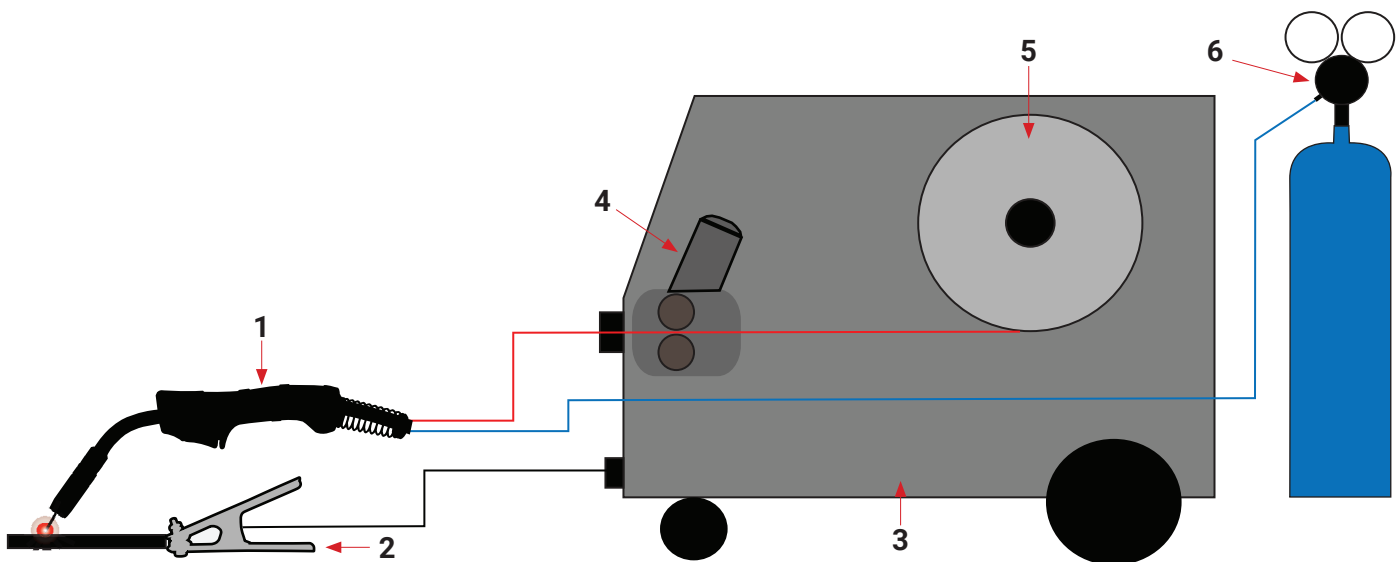

1. MIG Torch - 2. Work Piece - 3. Power Source - 4. Wire Feeder - 5. Wire Spool - 6. Gas

MIG (Metal Inert Gas) Welding

Short Circuit Transfer - Short circuit transfer is the most common used method whereby the wire electrode is fed continuously down the welding torch through to and exiting the contact tip. The wire touches the work piece and causes a short circuit the wire heats up and begins to form a molten bead, the bead separates from the end of the wire and forms a droplet that is transferred into the weld pool. This process is repeated about 100 times per second, making the arc appear constant to the human eye.

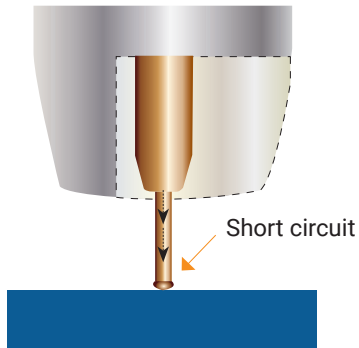

The wire approaches the work piece and touches the work creating a short circuit between the wire and the base metal, because there is no space between the wire and the base metal there is no arc and current flows through the wire.

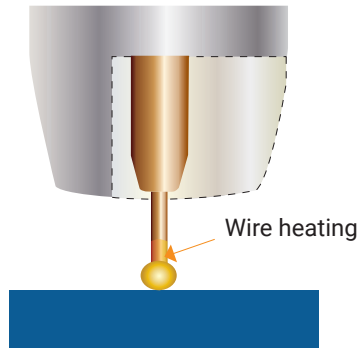

The wire cannot support all the current flow, resistance builds up and the wire becomes hot and weak and begins to melt

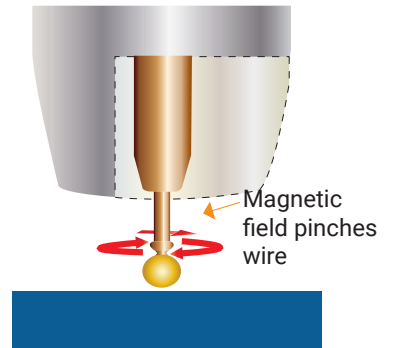

The current flow creates a magnetic field that begins to pinch the melting wire forming it into droplet

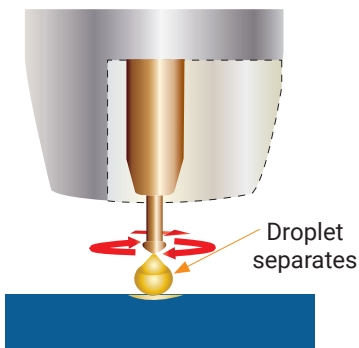

The pinch causes the forming droplet to separate and fall towards the now creating weld pool.

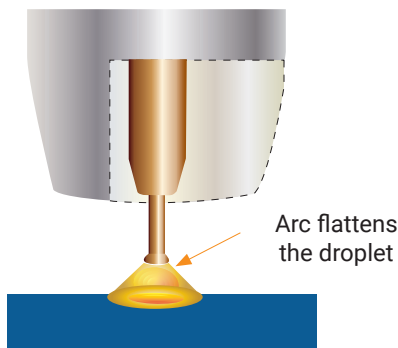

An arc is created at the separation of the droplet and the heat and force of the arc flattens out the droplet into the weld pool. The heat of the arc melts the end of the wire slightly as it feeds towards the base metal

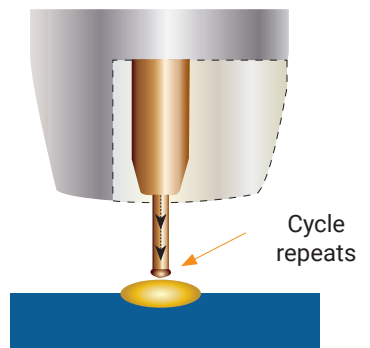

The wire feed speed overcomes the heat of the arc and the wire again approaches the work to short circuit and repeat the cycle.

Basic MIG Welding

Good weld quality and weld profile depends on gun angle, direction of travel, electrode extension (stick out), travel speed, thickness of base metal, wire feed speed (amperage) and arc voltage. To follow are some basic guides to assist with your setup.

Gun Position - Travel Direction, Work Angle

Gun position or technique usually refers to how the wire is directed at the base metal, the angle and travel direction chosen. Travel speed and work angle will determine the characteristic of the weld bead profile and degree of weld penetration.

Push Technique

The wire is located at the leading edge of the weld pool and pushed towards the un-melted work surface. This technique offers a better view of the weld joint and direction of the wire into the weld joint. Push technique directs the heat away from the weld puddle allowing faster travel speeds providing a flatter weld profile with light penetration - useful for welding thin materials. The welds are wider and flatter allowing for minimal clean up / grinding time.

Perpendicular Technique

The wire is fed directly into the weld, this technique is used primarily for automated situations or when conditions make it necessary. The weld profile is generally higher and a deeper penetration is achieved.

Drag Technique

The gun and wire is dragged away from the weld bead. The arc and heat is concentrated on the weld pool, the base metal receives more heat, deeper melting, more penetration and the weld profile is higher with more build up.

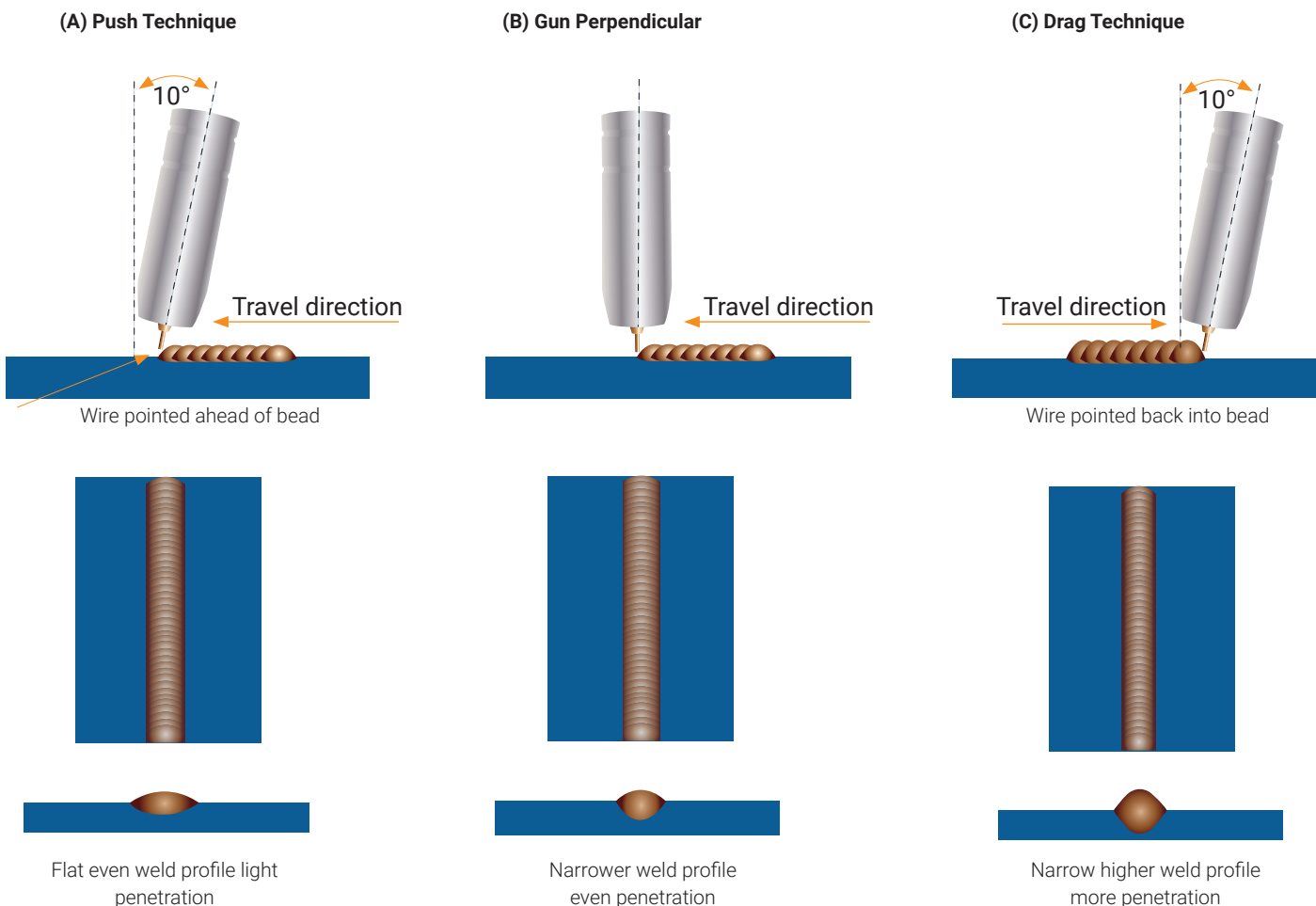

Travel Angle

Travel angle is the right to left angle relative to the direction of welding. A travel angle of 5°- 15° is ideal and produces a good level of control over the weld pool. A travel angle greater than 20° will give an unstable arc condition with poor weld metal transfer, less penetration, high levels of spatter, poor gas shield and poor quality finished weld.

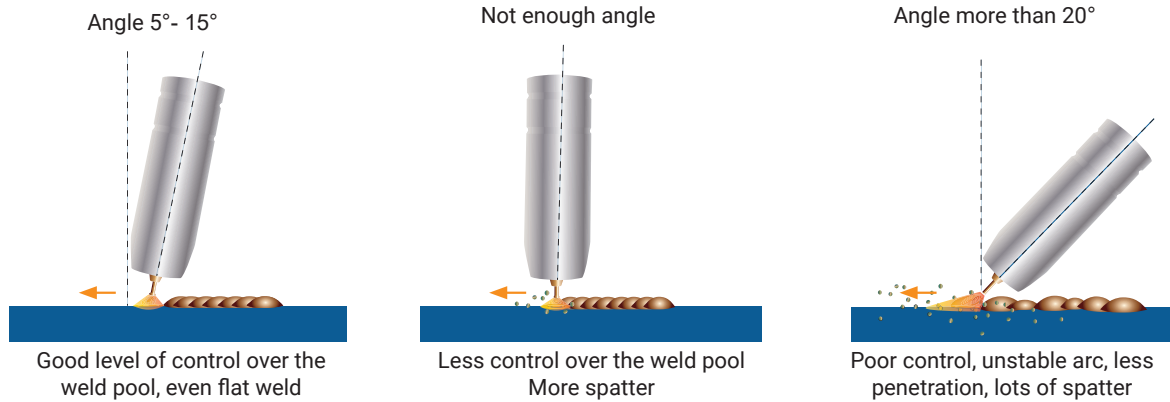

Angle to Work

The work angle is the forward back angle of the gun relative to the work piece.

The correct work angle provides good bead shape, prevents undercut, uneven penetration, poor gas shield and poor quality finished weld.

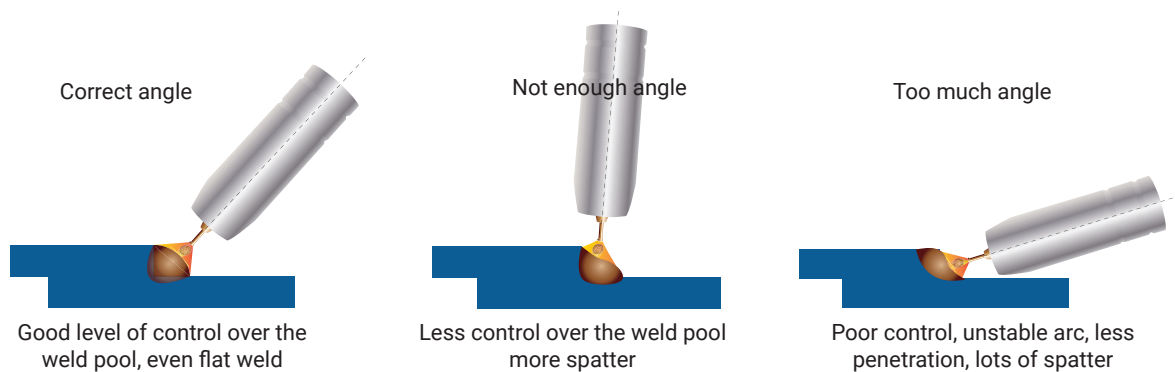

Stick Out

Stick out is the length of the unmelted wire protruding from the end of the contact tip.

A constant even stick out of 5-10mm will produce a stable arc, and an even current flow providing good penetration and even fusion. Too short stick out will cause an unstable weld pool, produce spatter and over heat the contact tip. Too long stick out will cause an unstable arc, lack of penetration, lack of fusion and increase spatter.

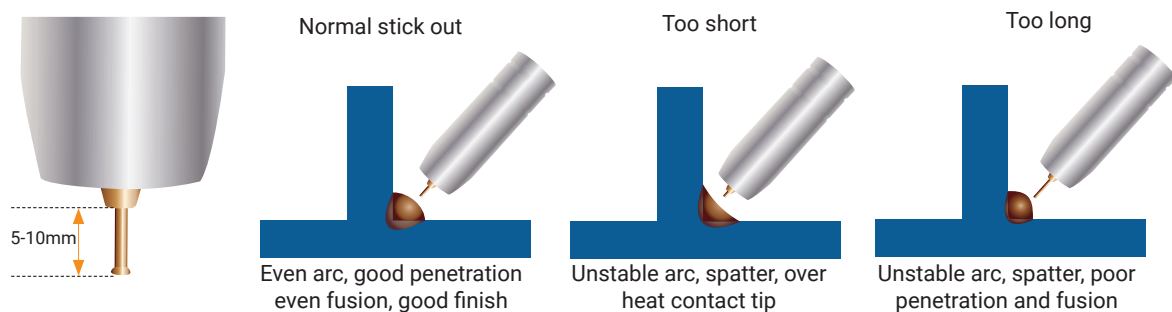

Travel Speed

Travel speed is the rate that the gun is moved along the weld joint and is usually measured in mm per minute. Travel speeds can vary depending on conditions and the welders skill and is limited to the welders ability to control the weld pool. Push technique allows faster travel speeds than Drag technique. Gas flow must also correspond with the travel speed, increasing with faster travel speed and decreasing with slower speed. Travel speed needs to match the amperage and will decrease as the material thickness and amperage increase.

Too Fast Travel Speed

A too fast travel speed produces too little heat per mm of travel resulting in less penetration and reduced weld fusion, the weld bead solidifies very quickly trapping gases inside the weld metal causing porosity. Undercutting of the base metal can also occur and an unfilled groove in the base metal is created when the travel speed is too fast to allow molten metal to flow into the weld crater created by the arc heat.

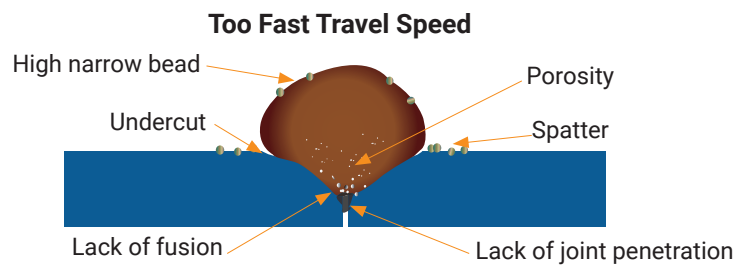

Too Slow Travel Speed

A too slow travel speed produces a large weld with lack of penetration and fusion. The energy from the arc dwells on top of the weld pool rather than penetrating the base metal. This produces a wider weld bead with more deposited weld metal per mm than is required resulting in a weld deposit of poor quality.

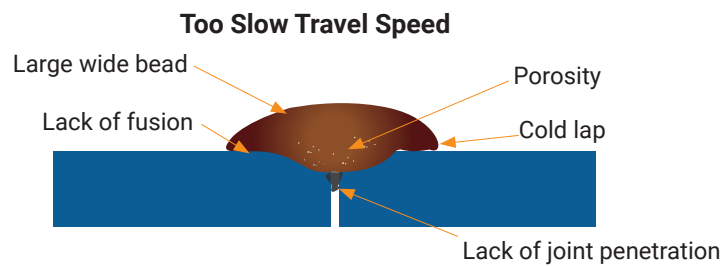

Correct Travel Speed

The correct travel speed keeps the arc at the leading edge of the weld pool allowing the base metal to melt sufficiently to create good penetration, fusion and wetting out of the weld pool producing a weld deposit of good quality.

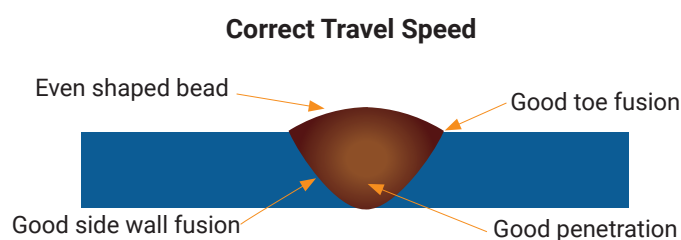

Wire types and sizes

Use the correct wire type for the base metal being welded. Use stainless steel wire for stainless steel, aluminium wires for aluminium and steel wires for steel.

Use a smaller diameter wire for thin base metals. For thicker materials use a larger wire diameter and larger machine, check the recommended welding capability of your machine.

As a guide refer to the "Welding Wire Thickness Chart" below.

WELDING WIRE DIAMETER CHART							
MATERIAL THICKNESS	RECOMMENDED WIRE DIAMETERS						
	MIG SOLID WIRE				GASLESS FLUX CORED WIRE		
	0.6mm	0.8mm	0.9mm	1.0mm	0.8mm	0.9mm	1.2mm
24 Gauge (.60mm)	Yellow						
22 Gauge (.75mm)	Yellow	Yellow			Yellow		
20 Gauge (.90mm)	Yellow	Yellow			Yellow	Yellow	
18 Gauge (1.0mm)	Yellow	Yellow	Yellow		Yellow	Yellow	
16 Gauge (1.2mm)		Yellow	Yellow		Yellow	Yellow	Yellow
14 Gauge (1.9mm)		Yellow	Yellow	Yellow	Yellow	Yellow	Yellow
3.0mm		Yellow	Yellow	Yellow		Yellow	Yellow
5.0mm			Yellow	Yellow		Yellow	Yellow
6.0mm			Yellow	Yellow			Yellow
8.0mm			Yellow	Yellow			Yellow
10.mm				Yellow			Yellow
12.0mm				Yellow			

For material thickness of 5.0mm and greater, multi-pass runs or a beveled joint design may be required depending on the amperage capability of your machine.

Gas selection

The purpose of the gas in the MIG process is to protect / shield the wire, the arc and the molten weld metal from the atmosphere. Most metals when heated to a molten state will react with the air in the atmosphere, without the protection of the shielding gas the weld produced would contain defects like porosity, lack of fusion and slag inclusions. Additionally some of the gas becomes ionised (electrically charged) and helps the current flow smoothly.

The correct gas flow is also very important in protecting the welding zone from the atmosphere.

Too low flow will give inadequate coverage and result in weld defects and unstable arc conditions.

Too high flow can cause air to be drawn into the gas column and contaminate the weld zone.

Use the correct shielding gas. Co2 is good for steel and offers good penetration characteristics, the weld profile is narrower and slightly more raised than the weld profile obtained from Argon Co2 mixed gas. Argon Co2 mix gas offers better weld ability for thin metals and has a wider range of setting tolerance on the machine. Argon 80% Co2 20% is a good all round mix suitable for most applications.

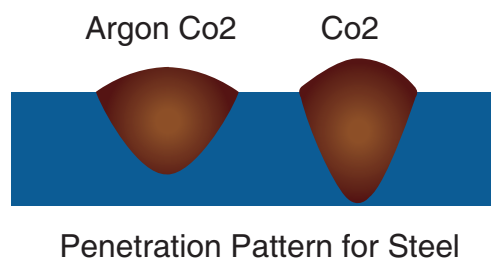

SPOOL GUN SETUP

UNIMIG
RazorWeld

1. Switch on the machine, select the MIG function with the MIG/MMA selector switch.
2. Select **Spool Gun** using the Standard/Spool Gun selector switch.
3. Connect the Spool Gun to the Euro Mig torch connection socket on the front panel, and tighten it. Connect the Spool Gun control cable to the receptacle and tighten it.
4. Insert the earth cable plug into the Negative socket on the front of the machine and tighten it.
5. Connect Gas Line to Gas Regulator and connect the gas regulator to the Gas Cylinder.
6. Connect the Weld power cable to the Positive socket.
7. Take the Spool Gun and push the Cover Release Button to unlock the wire feed / spool cover.
8. Place the Wire Spool onto the Spool Holder - Note: the spool retaining nut is Left Hand thread. Hold and snip the wire from the spool being sure to hold the wire to prevent rapid uncoiling.



SPOOL GUN SETUP

9. Carefully feed the wire over the drive roller into the outlet guide tube, feed through into the torch neck. Check that the drive roller being used complies with the wire diameter, replace the roller if necessary.
10. Align the wire into the groove of the drive roller and release the tension arm making sure the wire is in the groove of the drive roller.
11. Apply a medium amount of pressure to the drive roller by winding in the tension adjusting knob.
12. Remove the gas nozzle and contact tip from the torch neck, Pull the trigger to drive the wire through the neck until it exits the contact tip holder
13. Fit the correct sized contact tip and feed the wire through it, screw the contact tip into the tip holder of the torch neck and nip it up tightly.
14. Fit the gas nozzle to the torch head and close the wire feed spool cover
15. Carefully open the gas cylinder valve and set the flow rate to between 8-12 L/min.
16. Set the welding parameters using the wire feed and voltage control knobs.
17. Using the Burn Back control set the amount of wire to 'burn back' after you release the torch trigger. This prevents the wire becoming stuck in the weld pool when finishing the weld.

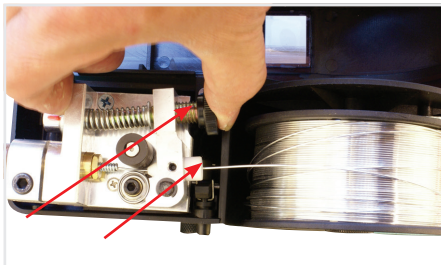

(9) Carefully feed the wire through the inlet guide tube onto the drive roller through into the outlet guide tube. Squeezing the tension arm adjustment knob to release the pressure of the tension arm will allow the wire to be guided through the drive roller easily

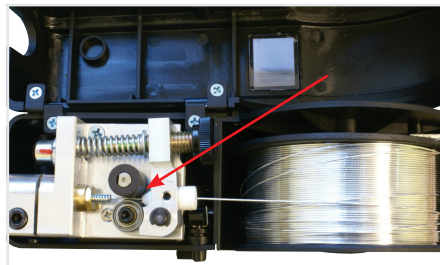

(10) Check to make sure that the wire passes cleanly through the drive roller into the outlet guide tube.

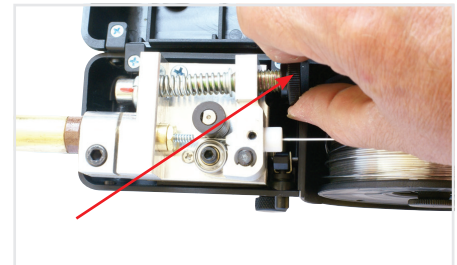

(11) Apply a medium amount of pressure using the tension arm adjustment knob.



(12) Remove the gas nozzle and contact tip. Pull the trigger to drive the wire through the neck until it exits the contact tip holder



(13) Fit the contact tip over the wire and screw it into the tip holder, nip it up tight.



(14) Fit the gas nozzle and close the wire feed spool cover



(15) Carefully open the valve of the gas cylinder, set the flow to 8-12 L/min



(16) Set welding parameters using the voltage and wire feed controls.



(17) Adjust the burn back control to prevent the wire sticking in the weld pool. Burn back control is located above the wire feed motor

MMA (STICK) WELDING SET UP

UNIMIG
RazorWeld

1. Turn the power source on and select the MMA function with the MIG/MMA selector switch.
2. **Connection of Output Cables**
Two sockets are available on this welding machine. For MMA welding the electrode holder is shown be connected to the positive socket, while the earth lead (work piece) is connected to the negative socket, this is known as DC+ polarity. However various electrodes require a different polarity for optimum results and careful attention should be paid to the polarity, refer to the electrode manufacturers information for the correct polarity.
DC+ Electrode connected to (+) output socket.
DC- Electrode connected to (-) output socket.
3. Set the welding current relevant to the electrode type and size being used as recommended by the electrode manufacturer.

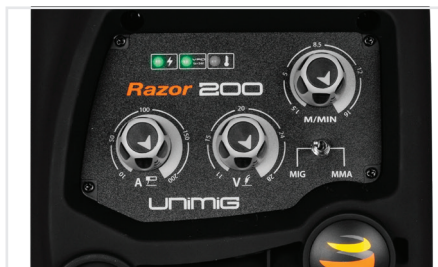

(3) Set the welding current using the amperage control dial.

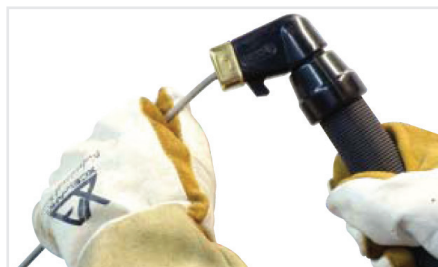

(4) Place the electrode into the electrode holder and clamp tight.



(5) Strike the electrode against the work-piece to create an arc and hold the electrode steady to maintain the arc.



(6) Hold the electrode slightly above the work maintaining the arc while travelling at an even speed.

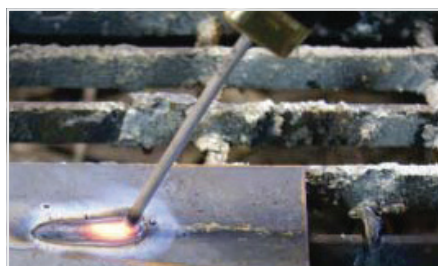

(7) To finish the weld, break the arc by quickly snapping the electrode away from the work piece.



(8) Wait for the weld to cool and carefully chip away the slag to reveal the weld metal below.

MMA (MANUAL METAL ARC) WELDING

One of the most common types of arc welding is manual metal arc welding (MMA) or MMA welding. An electric current is used to strike an arc between the base material and a consumable electrode rod or 'stick'. The electrode rod is made of a material that is compatible with the base material being welded and is covered with a flux that gives off gaseous vapours that serve as a shielding gas and providing a layer of slag, both of which protect the weld area from atmospheric contamination. The electrode core itself acts as filler material the residue from the flux that forms a slag covering over the weld metal must be chipped away after welding.

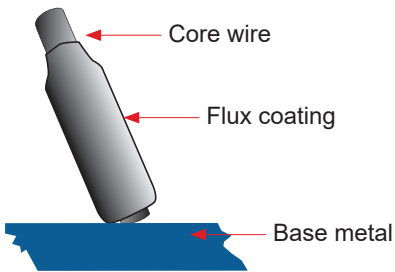
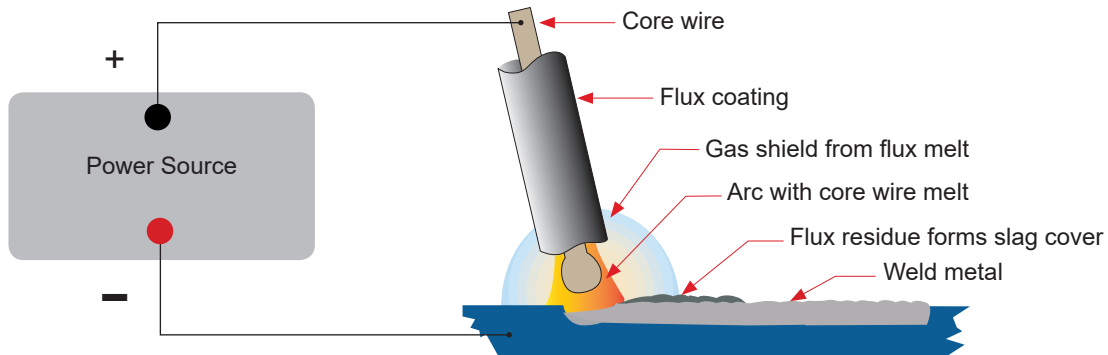

- The arc is initiated by momentarily touching the electrode to the base metal.
- The heat of the arc melts the surface of the base metal to form a molten pool at the end of the electrode.
- The melted electrode metal is transferred across the arc into the molten pool and becomes the deposited weld metal.
- The deposit is covered and protected by a slag which comes from the electrode coating.
- The arc and the immediate area are enveloped by an atmosphere of protective gas

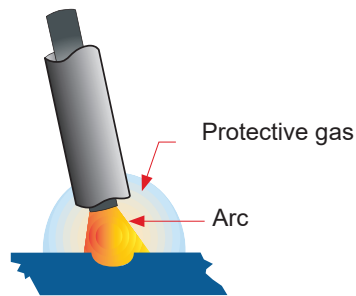

Manual metal arc (stick) electrodes have a solid metal wire core and a flux coating. These electrodes are identified by the wire diameter and by a series of letters and numbers. The letters and numbers identify the metal alloy and the intended use of the electrode.

The Metal Wire Core works as conductor of the current that maintains the arc. The core wire melts and is deposited into the welding pool.

The covering on a shielded metal arc welding electrode is called Flux. The flux on the electrode performs many different functions.

- These include:
- producing a protective gas around the weld area
- providing fluxing elements and deoxidisers
- creating a protective slag coating over the weld as it cools
- establishing arc characteristics
- adding alloying elements.

Covered electrodes serve many purposes in addition to adding filler metal to the molten pool. These additional functions are provided mainly by the covering on the electrode.

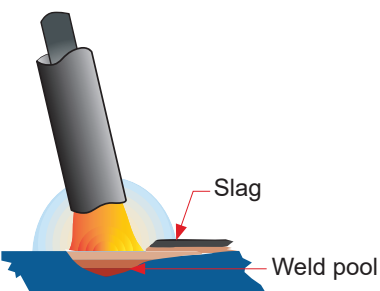

MMA (STICK) WELDING FUNDAMENTALS

ELECTRODE SELECTION

As a general rule, the selection of an electrode is straight forward, in that it is only a matter of selecting an electrode of similar composition to the parent metal. However, for some metals there is a choice of several electrodes, each of which has particular properties to suit specific classes of work. It is recommended to consult your welding supplier for the correct selection of electrode.

Average Thickness of Material	Maximum Recommended Electrode Diameter
1.0 - 2.0mm	2.5mm
2.0 - 5.0mm	3.2mm
5.0 - 8.0mm	4.0mm
8.0 - > mm	5.0mm

The size of the electrode generally depends on the thickness of the section being welded, and the thicker the section the larger the electrode required. The table gives the maximum size of electrodes that may be used for various thicknesses of section based on using a general purpose type 6013 electrode.

Electrode Size (ø mm)	Current Range (Amps)
2.5mm	60 - 100
3.2mm	100 - 130
4.0mm	130 - 165
5.0mm	165 - 260

Correct current selection for a particular job is an important factor in arc welding. With the current set too low, difficulty is experienced in striking and maintaining a stable arc. The electrode tends to MMA to the work, penetration is poor and beads with a distinct rounded profile will be deposited. Too high current is accompanied by overheating of the electrode resulting in undercut and burning through of the base metal and producing excessive spatter. Normal current for a particular job may be considered as the maximum, which can be used without burning through the work, overheating the electrode or producing a rough spattered surface. The table shows current ranges generally recommended for a general purpose type 6013 electrode.

ARC LENGTH

To strike the arc, the electrode should be gently scraped on the work until the arc is established. There is a simple rule for the proper arc length; it should be the shortest arc that gives a good surface to the weld. An arc too long reduces penetration, produces spatter and gives a rough surface finish to the weld. An excessively short arc will cause sticking of the electrode and result in poor quality welds. General rule of thumb for down hand welding is to have an arc length no greater than the diameter of the core wire.

ELECTRODE ANGLE

The angle that the electrode makes with the work is important to ensure a smooth, even transfer of metal. When welding in down hand, fillet, horizontal or overhead the angle of the electrode is generally between 5 and 15 degrees towards the direction of travel. When vertical up welding the angle of the electrode should be between 80 and 90 degrees to the work piece.

TRAVEL SPEED

The electrode should be moved along in the direction of the joint being welded at a speed that will give the size of run required. At the same time, the electrode is fed downwards to keep the correct arc length at all times. Excessive travel speeds lead to poor fusion, lack of penetration etc, while too slow a rate of travel will frequently lead to arc instability, slag inclusions and poor mechanical properties.

MATERIAL AND JOINT PREPARATION

The material to be welded should be clean and free of any moisture, paint, oil, grease, mill scale, rust or any other material that will hinder the arc and contaminate the weld material. Joint preparation will depend on the method used include sawing, punching, shearing, machining, flame cutting and others. In all cases edges should be clean and free of any contaminants. The type of joint will be determined by the chosen application.

SB24 MIG TORCH & SPARES



250A AIR COOLED MIG WELDING TORCH

RATING:250A CO² 220A MIXED GAS EN60974-7 @ 60% DUTY CYCLE. 0.8 TO 1.2MM WIRES

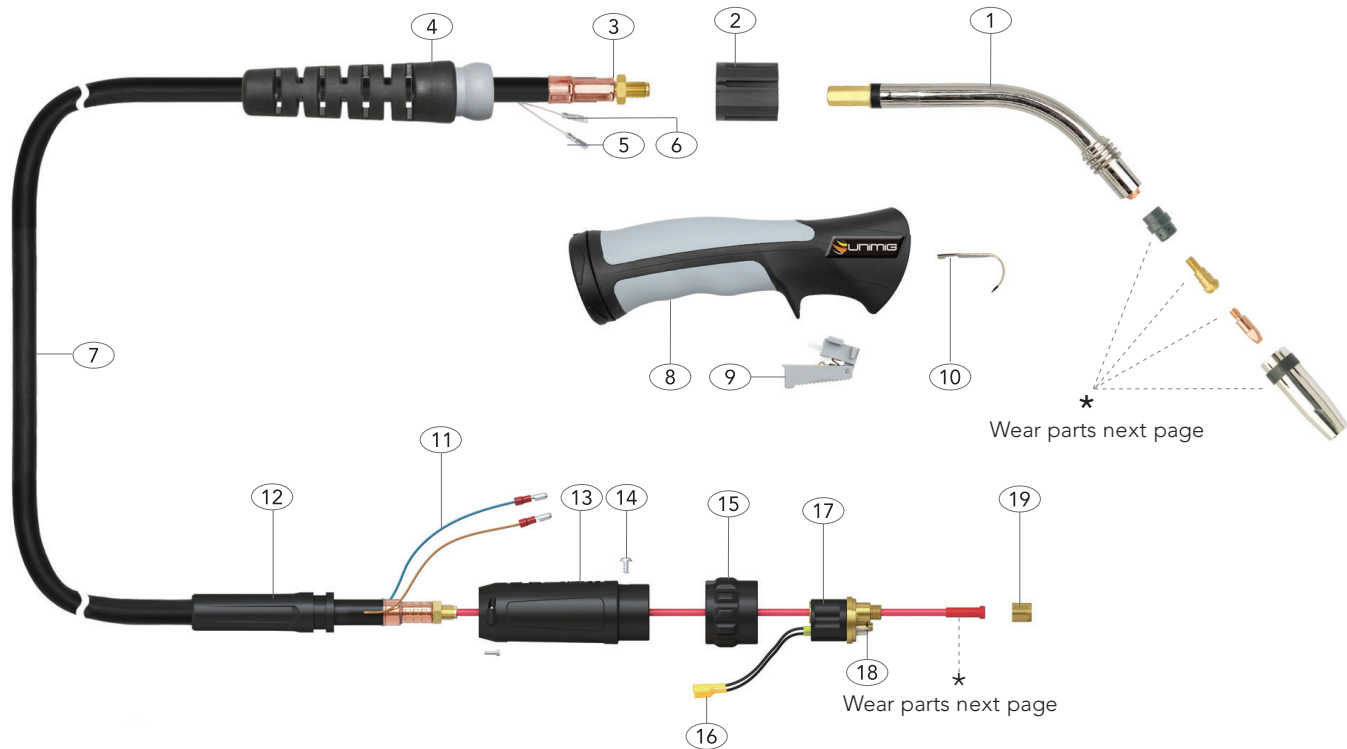

	Part No.		
Length	3m	4m	5m
SB24 Suregrip Ergo Torch Package	SB24-3M	SB24-4M	SB24-5M

Part-No	Description
1	SNK24 Swan Neck Assembly
2	UG1515 Ergo Handle Location Body
3	UB1505 Lock Nut
4	UG8015 Handle Cable Support C/W Ball Joint
5	UB1521 Cable Terminal
6	UB1521-C Cable Terminal Cover
7	UB2603-30 Hyperflex Cable Assembly x 3mt
	UB2603-40 Hyperflex Cable Assembly x 4mt
	UB2603-50 Hyperflex Cable Assembly x 5mt
8	UG2514 Ergo Handle Kit C/W Lock Nut
9	UG2516 Medium / Large Ergo Trigger

Part-No	Description
10	UB2517 Hanger Hook
11	UB1522 Cable Terminal Male
12	UPA2041 Cable Support
13	UB1518 Gun Plug Housing C/W Nut
14	UB1541 Gun Plug Screw
15	UB1519/S Gun Plug Nut
16	UB1523 Gun Plug Terminal Female
17	UC1528 Hybrid Gun Plug Body C/W Spring Pins
18	UB1524 Gun Plug 'O' Ring
19	UB1525 Liner Nut

FRONT END CONSUMABLES

SB24 CONTACT TIPS

Part-No	Description	QTY
PCT0009-06	Contact Tip Steel (0.6mm)	QTY10
PCT0009-08	Contact Tip Steel (0.8mm)	QTY10
PCT0009-09	Contact Tip Steel (0.9mm)	QTY10
PCT0009-10	Contact Tip Steel (1.0mm)	QTY10
PCT0009-12	Contact Tip Steel (1.2mm)	QTY10
PCT0009-16	Contact Tip Steel (1.6mm)	QTY10
PCTAL0009-09	Contact Tip Aluminium (0.9mm)	QTY10
PCTAL0009-10	Contact Tip Aluminium (1.0mm)	QTY10
PCTAL0009-12	Contact Tip Aluminium (1.2mm)	QTY10

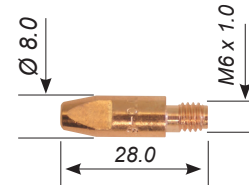

SB24 TIP HOLDER

Part-No	Description	QTY
PCTH24	Contact Tip Holder	QTY2

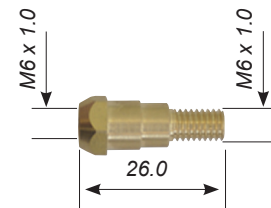

SB24 GAS DIFFUSER

Part-No	Description	QTY
PCGD24	Gas Diffuser	QTY2
PCGD24R	Rubber Gas Diffuser	QTY2

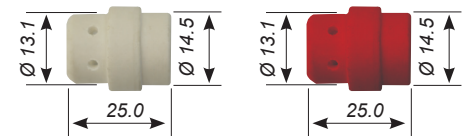

SB24 GAS NOZZLE

Part-No	Description	QTY
PGN24CYL	Cylindrical Nozzle	QTY2
PGN24CON	Conical Nozzle	QTY2
PGN24TAP	Tapered Nozzle	QTY2
PGN24SPOT	Spot Nozzle	QTY2

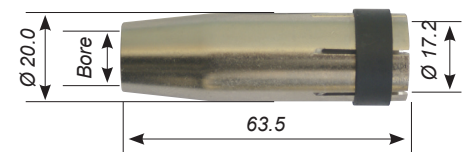

SB24 LINERS

Part-No	Description	
SLB3M	Blue Steel Liner 3 Metre	0.6 - 0.8mm
SLB4M	Blue Steel Liner 4 Metre	0.6 - 0.8mm
SLB5M	Blue Steel Liner 5 Metre	0.6 - 0.8mm
SLR3M	Red Steel Liner 3 Metre	0.9 - 1.2mm
SLR4M	Red Steel Liner 4 Metre	0.9 - 1.2mm
SLR5M	Red Steel Liner 5 Metre	0.9 - 1.2mm
TLB3M	Blue Aluminium Liner 3 Metre	0.6 - 0.8mm
TLB4M	Blue Aluminium Liner 4 Metre	0.6 - 0.8mm
TLR3M	Red Aluminium Liner 3 Metre	0.9 - 1.2mm
TLR4M	Red Aluminium Liner 4 Metre	0.9 - 1.2mm
TLY3M	Yellow Aluminium Liner 3 Metre	1.2 - 1.6mm
TLY4M	Yellow Aluminium Liner 4 Metre	1.2 - 1.6mm
NKSTL	Neck Spring for Aluminium	

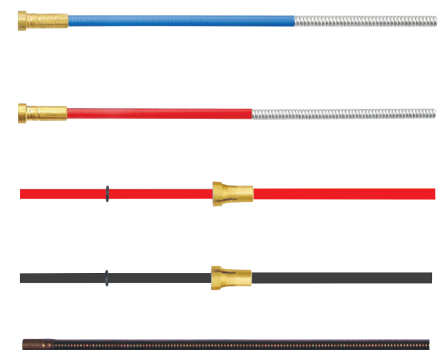

These parts are manufactured in China and are offered as replacement parts suitable for "BINZEL®" style torches.

MIG WELDING TROUBLE SHOOTING



The following chart addresses some of the common problems of MIG welding. In all cases of equipment malfunction, the manufacturer's recommendations should be strictly adhered to and followed.

1: Excessive Spatter	
Possible Reason	Suggested Remedy
Wire feed speed set too high	Select lower wire feed speed
Voltage too high	Select a lower voltage setting
Wrong polarity set	Select the correct polarity for the wire being used - see machine setup guide
Stick out too long	Bring the torch closer to the work
Contaminated base metal	Remove materials like paint, grease, oil, and dirt, including mill scale from base metal
Contaminated MIG wire	Use clean dry rust free wire. Do not lubricate the wire with oil, grease etc
Inadequate gas flow or too much gas flow	Check the gas is connected, check hoses, gas valve and torch are not restricted. Set the gas flow between 6-12 l/min flow rate. Check hoses and fittings for holes, leaks etc Protect the welding zone from wind and drafts
2: Porosity - small cavities or holes resulting from gas pockets in weld metal.	
Possible Reason	Suggested Remedy
Wrong gas	Check that the correct gas is being used
Inadequate gas flow or too much gas flow	Check the gas is connected, check hoses, gas valve and torch are not restricted. Set the gas flow between 10 - 15 l/min flow rate. Check hoses and fittings for holes, leaks etc. Protect the welding zone from wind and drafts
Moisture on the base metal	Remove all moisture from base metal before welding
Contaminated base metal	Remove materials like paint, grease, oil, and dirt, including mill scale from base metal
Contaminated MIG wire	Use clean dry rust free wire. Do not lubricate the wire with oil, grease etc
Gas nozzle clogged with spatter, worn or out of shape	Clean or replace the gas nozzle
Missing or damaged gas diffuser	Replace the gas diffuser
MIG torch Euro connect o-ring missing or damaged	Check and replace the o-ring
3: Wire stubbing during welding	
Possible Reason	Suggested Remedy
Holding the torch too far away	Bring the torch closer to the work and maintain stick out of 5-10mm
Welding voltage set too low	Increase the voltage
Wire Speed set too high	Decrease the wire feed speed
4: Lack of Fusion - failure of weld metal to fuse completely with base metal or a preceding weld bead.	
Possible Reason	Suggested Remedy
Contaminated base metal	Remove materials like paint, grease, oil, and dirt, including mill scale from base metal
Not enough heat input	Select a higher voltage range and /or adjust the wire speed to suit
Improper welding technique	Keep the arc at the leading edge of the weld pool. Gun angle to work should be between 5 & 15° Direct the arc at the weld joint Adjust work angle or widen groove to access bottom during welding Momentarily hold arc on side walls if using weaving technique
5: Excessive Penetration - weld metal melting through base metal	
Possible Reason	Suggested Remedy
Too much heat	Select a lower voltage range and /or adjust the wire speed to suit Increase travel speed
6: Lack of Penetration - shallow fusion between weld metal and base metal	
Poor in incorrect joint preparation	Material too thick. Joint preparation and design needs to allow access to bottom of groove while maintaining proper welding wire extension and arc characteristics Keep the arc at the leading edge of the weld pool and maintain the gun angle at 5 & 15° keeping the stick out between 5-10mm
Not enough heat input	Select a higher voltage range and /or adjust the wire speed to suit Reduce travel speed
Contaminated base metal	Remove materials like paint, grease, oil, and dirt, including mill scale from base metal.

MIG WIRE FEED TROUBLE SHOOTING



The following chart addresses some of the common WIRE FEED problems during MIG welding. In all cases of equipment malfunction, the manufacturer's recommendations should be strictly adhered to and followed.

1: No wire feed	
Possible Reason	Suggested Remedy
Wrong mode selected	Check that the TIG/MMA/MIG selector switch set to MIG position
Wrong torch selector switch	Check that the STANDARD/SPOOL GUN selector switch is set to STANDARD position for MIG welding and SPOOL GUN when using the spool gun
2: Inconsistent / interrupted wire feed	
Possible Reason	Suggested Remedy
Adjusting wrong dial	Be sure to adjust the WIRE FEED and VOLTAGE dials for MIG welding. The AMPERAGE dial is for STICK and TIG welding mode
Wrong polarity selected	Select the correct polarity for the wire being used - see machine setup guide
Incorrect wire speed setting	Adjust the wire feed speed
Voltage setting incorrect	Adjust the voltage setting
MIG torch lead too long	Small diameter wires and soft wires like aluminium don't feed well through long torch leads - replace the torch with a lesser length torch
MIG torch lead kinked or too sharp angle being held	Remove the kink, reduce the angle or bend
Contact tip worn, wrong size, wrong type	Replace the tip with correct size and type
Liner worn or clogged (the most common causes of bad feeding)	Try to clear the liner by blowing out with compressed air as a temporary cure, it is recommended to replace the liner
Wrong size liner	Install the correct size liner
Blocked or worn inlet guide tube	Clear or replace the inlet guide tube
Wire misaligned in drive roller groove	Locate the wire into the groove of the drive roller
Incorrect drive roller size	Fit the correct size drive roller e.g.; 0.8mm wire requires 0.8mm drive roller
Wrong type of drive roller selected	Fit the correct type roller (e.g. knurled rollers needed for flux cored wires)
Worn drive rollers	Replace the drive rollers
Drive roller pressure too high	Can flatten the wire electrode causing it to lodge in the contact tip - reduce the drive roller pressure
Too much tension on wire spool hub	Reduce the spool hub brake tension
Wire crossed over on the spool or tangled	Remove the spool untangle the wire or replace the wire
Contaminated MIG wire	Use clean dry rust free wire. Do not lubricate the wire with oil, grease etc

MMA (STICK) WELDING TROUBLE SHOOTING



The following chart addresses some of the common problems of MMA welding. In all cases of equipment malfunction, the manufacturer's recommendations should be strictly adhered to and followed.

1: No arc	
Possible Reason	Suggested Remedy
Incomplete welding circuit	Check earth lead is connected. Check all cable connections.
Wrong mode selected	Check the MMA selector switch is selected
No power supply	Check that the machine is switched on and has a power supply
2: Porosity – small cavities or holes resulting from gas pockets in weld metal.	
Possible Reason	Suggested Remedy
Arc length too long	Shorten the arc length
Work piece dirty, contaminated or moisture	Remove moisture and materials like paint, grease, oil, and dirt, including mill scale from base metal
Damp electrodes	Use only dry electrodes
3: Excessive Spatter	
Possible Reason	Suggested Remedy
Amperage too high	Decrease the amperage or choose a larger electrode
Arc length too long	Shorten the arc length
3: Weld sits on top, lack of fusion	
Possible Reason	Suggested Remedy
Insufficient heat input	Increase the amperage or choose a larger electrode
Work piece dirty, contaminated or moisture	Remove moisture and materials like paint, grease, oil, and dirt, including mill scale from base metal
Poor welding technique	Use the correct welding technique or seek assistance for the correct technique
4: Lack of penetration	
Possible Reason	Suggested Remedy
Insufficient heat input	Increase the amperage or choose a larger electrode
Poor welding technique	Use the correct welding technique or seek assistance for the correct technique
Poor joint preparation	Check the joint design and fit up, make sure the material is not too thick. Seek assistance for the correct joint design and fit up
5: Excessive penetration - burn through	
Possible Reason	Suggested Remedy
Excessive heat input	Reduce the amperage or use a smaller electrode
Incorrect travel speed	Try increasing the weld travel speed
6: Uneven weld appearance	
Possible Reason	Suggested Remedy
Unsteady hand, wavering hand	Use two hands where possible to steady up, practise your technique
7: Distortion – movement of base metal during welding	
Possible Reason	Suggested Remedy
Excessive heat input	Reduce the amperage or use a smaller electrode
Poor welding technique	Use the correct welding technique or seek assistance for the correct technique
Poor joint preparation and or joint design	Check the joint design and fit up, make sure the material is not too thick. Seek assistance for the correct joint design and fit up
7: Electrode welds with different or unusual arc characteristic	
Possible Reason	Suggested Remedy
Incorrect polarity	Change the polarity, check the electrode manufacturer for correct polarity

SPARE PARTS IDENTIFICATION

UNIMIG
RazorWeld

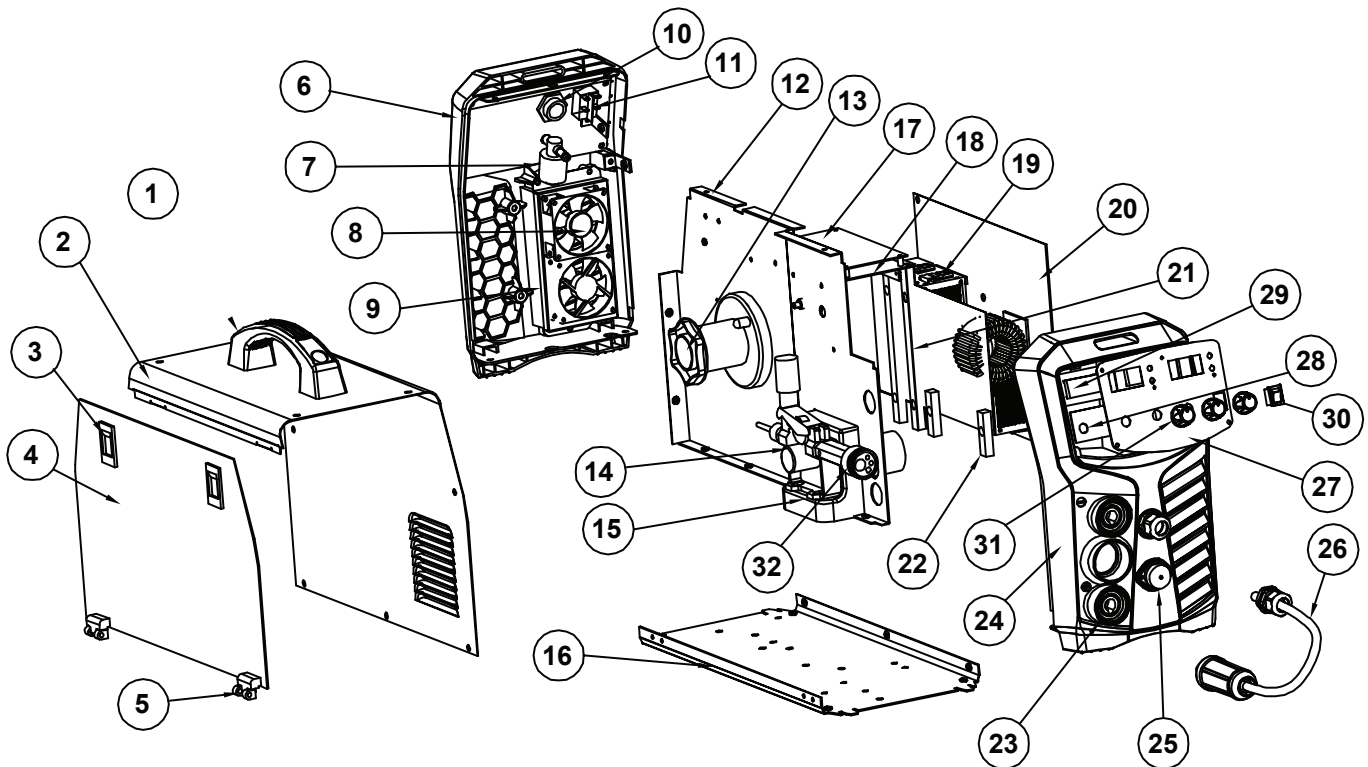

#	Part Number	Description	#	Part Number	Description
1	10050074	Handle	17	10068362	Control board
2		Machine cover	18		Control supportof
3	10016524	Door holder	19	10068364	Inverter
4		Side cover plate	20	10068361	Main board
5	10052166	Loose-leaf	21	10054164	Long column
6		Back panel	22	10054163	Short column
7	10001381	Valve	23	10045432	Output terminal
8	10041446	FAN	24		Front panel
9	10068372	Fan Supportof	25	10068218	Aviation socket
10		Cable clip	26	10068359	Handle line
11	10047746	Power switch	27	10068387	Control board fixed plate
12	10068406	Median baffle	28	10068349	Control panel
13	10054475	Wire feeding spindle	29	10046712	Meter
14	10068410	Wire feeder	30	10026117	Change-over switch
15	10041716	Wire feeder fixed cover	31		Knob
16	10068307	Bottom plate	32	10068360	Euro connector

WARRANTY TERMS



Welding Guns Of Australia Pty Ltd ('Us', 'We') warrants that the following products under UNIMIG, UNI-TIG, UNI-PLAS, UNI-FLAME, TECNA, T&R, HIT-8SS & ROTA, supplied by Us and purchased by you from an Authorised UNIMIG, UNI-TIG, UNI-PLAS, UNI-FLAME, TECNA, T&R, HIT-8SS & ROTA Dealer throughout Australia are free of Material and Faulty Workmanship defects except for those products listed under 'Warranty Exclusions'.

These terms and conditions supersede and exclude all former and other representations and arrangements relating to any warranties on these products.

WARRANTY PERIOD

We offer the following 'Warranty Periods' from 'date of purchase':

An Extended Warranty Period of 6 months total shall apply only to Machinery where offered and warranty is registered online.

UNIMIG WELDING MACHINES

UNIMIG DIY Series (Power Source Only)	2 Years	(Clause 3)
UNIMIG Procraft Series (Power Source Only)	3 Years	(Clause 1&3)
UNIMIG Trade Series (Power Source Only)	3 Years	(Clause 1&3)
UNIMIG Trade Series SWF (Power Source / Separate Wire Feeder Only)	3 Years	(Clause 1&3)
UNIMIG Workshop Series (Power Source Only)	3 Years	(Clause 1&3)
UNIMIG Workshop Series SWF (Power Source / Separate Wire Feeder Only)	3 Years	(Clause 1&3)
UNIMIG Jasic Inverter MIG (Power Source Only)	3 Years	(Clause 3)
UNIMIG Jasic Inverter MIG SWF (Power Source / Separate Wire Feeder Only)	3 Years	(Clause 3)
UNI-TIG Jasic Inverter TIG (Power Source Only)	3 Years	(Clause 3)
UNIMIG Water Cooler	1 Year	(Clause 3)
T&R Pulse MIG (Power Source Only)	2 Year	(Clause 3)
T&R Pulse MIG SWF (Power Source / Separate Wire Feeder Only)	2 Year	(Clause 3)
UNI-PLAS (Power Source Only)	3 Years	(Clause 3)
UNI-PLAS Jasic Series (Power Source Only)	2 Years	(Clause 3)
UNI-PLAS Site Cut Series (Power Source Only)	1 Year	(Clause 3)
UNI-FLAME Gas Cutting and Welding Kits	3 Months	(Clause 2&3)
UNI-FLAME Straight Line & Gas Cutting Machines (Power Source Only)	1 Year	(Clause 3)
UNI-FLAME Regulators Argon/ Acetylene / Oxygen / LPG / Bobbin Flowmeter	1 Year	
UNI-FLAME Automatic Welding Helmet	2 Years	
UNIMIG Automatic Welding Helmets	2 Years	
TECNA (Power Source Only)	1 Year	(Clause 3)
HIT-8SS Automatic Carriage (Power Source Only)	1 Year	(Clause 3)
ROTA 102 Rotating table	1 Year	
HOTBOX Electrode Oven	1 Year	
SPOTCAR 3500	1 Year	(Clause 3)
TORCHES -GMAW, GTAW, MMAW, PLASMA, EARTH LEADS, INTERCONNECTING CABLES, GAS HOSE	3 Months	(Clause 3)
UNIMIG VIPER RANGE	1 Year	
UNIMIG VIPER 185	2 Years	

(Clause 1) 3 year warranty on transformers, inductor and rectifier. 1 year warranty on PCB, and all other components, .

(Clause 2) Gas Hose, Flashbacks are subject to and covered by the Manufacturer's Individual Warranty, Contact the manufacturer for details

(Clause 3) This only Covers Manufactures defaults on all accessories for the first three months after date of purchase.

WARRANTY / RETURNS / EXCHANGES

We understand that sometimes you may need to return a product you have purchased from Welding Guns Of Australia PTY LTD Authorised Dealer Network, to assist you, we have set out below the Welding Guns Of Australia PTY LTD Returns Policy that you should know.

Our Returns Policy includes the rights you have under the Australian Consumer Law and other relevant laws.

Your Rights under the Australian Consumer Law - Our goods come with guarantees that cannot be excluded under the Australian Consumer Law. You are entitled to a replacement or refund for a major failure and for compensation for any other reasonably foreseeable loss or damage. You are also entitled to have the goods repaired or replaced if the goods fail to be of acceptable quality and the failure does not amount to a major failure.

- You shall inspect the Goods on delivery and shall within seven (7) days of delivery (time being of the essence) notify Welding Guns Of Australia PTY LTD of any alleged defect, shortage in quantity, damage or failure to comply with the description or quote.
- You shall also afford Welding Guns Of Australia PTY LTD the opportunity to inspect the Goods within a reasonable time following delivery if you believe the Goods are defective in any way.
- If you shall fail to comply with these provisions the Goods shall be presumed to be free from any defect or damage. For defective Goods, which Welding Guns Of Australia PTY LTD has agreed in writing that you are entitled to reject, Welding Guns Of Australia PTY LTD liability is limited to either (at the Welding Guns Of Australia PTY LTD discretion) replacing the Goods or repairing the Goods except where you have acquired Goods as a consumer within the meaning of the Trade Practices Act 1974 or the Fair Trading Acts of the relevant state or territories of Australia, and is therefore also entitled to, at the consumer's discretion either a refund of the purchase price of the Goods, or repair of the Goods, or replacement of the Goods.

Returns will only be accepted provided that:

- a. You have complied with the provisions outlined above, and
 - b. Where the Goods are unable to be repaired, the Goods are returned at your cost within thirty (30) days of the delivery date, and
 - c. Welding Guns Of Australia PTY LTD will not be liable for Goods which have not been stored or used in a proper manner, and
 - d. The Goods are returned in the condition in which they were delivered and with all packaging material, brochures and instruction material in as new condition as is reasonably possible in the circumstances.
- Welding Guns Of Australia PTY LTD Accepts no responsibility for products lost, damaged or mislaid whilst in transit
 - Welding Guns Of Australia PTY LTD may (at their sole discretion) accept the return of Goods for credit but this may incur a handling fee of up to fifteen percent (15%) of the value of the returned Goods plus any freight costs.
 - Where a failure does not amount to a major failure, Welding Guns Of Australia PTY LTD is entitled to choose between providing you with a repair, replacement or other suitable remedy.
 - Your rights under the Australian Consumer Law are not limited by a defined time. However, the Australian Consumer Law does recognise that the relevant time period can vary from product to product, depending on factors such as the nature of the product and the price. Welding Guns Of Australia PTY LTD adopts the same approach. As you can appreciate, the type of remedy we can offer you may also vary depending on how long it takes you to return the product to us.

MAKING A CLAIM

If you wish to make a claim under this Warranty, you should:

- Return the product to the point of purchase either in person or on a prepaid courier; or
- Contact Us by Telephone on 02 9870 4200 or Mail PO Box 3033 Lansvale NSW 2166.

When returned, the product must be accompanied with the original invoice including the purchase price and disclosing the purchase date

All costs of installation, cartage, freight, travelling expenses, hiring tools and insurance are paid by the Customer.

To the extent permitted by law, our total liability for loss or damage of every kind related to the product in any way whatsoever is limited to the amount paid to the retailer by you for the product or the value of the product.

No responsibility will be taken for products lost, damaged or mislaid whilst in transit.

WARRANTY EXCLUSIONS

This Warranty covers Material and Faulty Workmanship defects only.

This Warranty does not cover damage caused by:

- Normal wear and tear due to usage
- Misuse or abusive use of the UNIMIG, UNI-TIG, UNI-PLAS, UNI-FLAME, TECNA, T&R, HIT-8SS & ROTA, instructions supplied with the product.
- Failure to clean or improper cleaning of the product
- Failure to maintain the equipment such as regular services etc
- Incorrect voltage or non-authorized electrical connections
- Improper installation
- Use of non-authorized/non-standard parts
- Abnormal product performance caused by any ancillary equipment interference or other external factors
- Failure or any breakage caused by overload, dropping or abusive treatment or use by the customer
- Repair, modifications or other work carried out on the product other than by an Authorized UNIMIG, UNI-TIG, UNI-PLAS, UNI-FLAME, TECNA, T&R, HIT-8SS & ROTA Service Dealer

Unless it is a manufacturing fault, this Warranty does not cover the following parts:

MIG Welding Torches and Consumables to suit, such as:

Gas Nozzles, Gas Diffusers, Contact Tip holder, Contact tip, Swan Necks, Trigger, Handle, Liners, Wire Guide, Drive Roller, Gas Nozzle Spring, Neck Spring, Connector Block, Insulator, Gas Nipple, Cap, Euro Block, Head Assembly, Gas Block, Trigger Spring, Spring Cable Support, Neck Insulator, Shroud Spring, Gun Plug Cover, Lock Nut, Snap On Head, Spring Cap, Ball, Motor 42 Volt, Pot 10K standard, Knob, Drive Roll Seat, Washer, Bow, Ball Bearing, Wire Conduite Nipple, Central Plug, Printed Circuit Board, Gun Plug House, Cable Support, Gas Connector, Handle To Suit PP36 with Knobs, All Xcel-Arc/ Magmaweld MIG Welding Wires & Electrodes, Arc Leads, Welding Cable, Electrode Holder, Earth Clamps

TIG Welding Torches and Consumables to suit, such as:

Tungsten Electrodes, Collet, Collet Body, Alumina Nozzle, Torch Head, Torch Head water Cooled, Torch Head Flexible, Back Caps, Gas Lens, Torch Handle, Cup Gasket, Torch Body Gas Valve, O-ring, All UNIMIG TIG Welding Rods, All Xcel-Arc/ Magmaweld Electrodes, Arc Leads, Welding Cable, Electrode Holder, Earth Clamps.

PLASMA Cutting Torches and Consumables to suit, such as:

All Cutting Tips, All Diffuser/Swirl Ring, All Electrode, Retaining Caps, Nozzle Springs, All Spacers, All Shield Caps, All Air and Power Cables, All Switches, All O-rings, All Springs, All Circle Guides and Cutting Kits, Torch Bodies, Air Filter Regulator, Arc Leads, Welding Cable, Electrode Holder, Earth Clamps

STRAIGHT LINE CUTTING MACHINES and Consumables to suit, such as:

Hoses, Fittings, Track, Cutting Nozzles.

HIT-8SS Welding Carriage Consumables to suit, such as:

Input Cord, Inter-connecting Cord, Triggering Cable.

This Warranty does not cover products purchased:

- From a non-authorized UNIMIG, UNI-TIG, UNI-PLAS, UNI-FLAME, TECNA, T&R, HIT-8SS & ROTA Dealer (such as purchases from unauthorised retailers and purchases over the Internet from unauthorised local/international sellers or sites such as EBay)
- At an auction;
- From a private seller

Unless it is a manufacturing fault, this Warranty does not apply to any products sold to Hire Companies.

These conditions may only be varied with the written approval of the Directors of Welding Guns Of Australia PTY LTD

REMEMBER TO RETAIN YOUR ORIGINAL INVOICE FOR PROOF OF PURCHASE.



UNIMIG

Welding Guns Of Australia Pty Ltd

ABN: 14 001 804 422

PO Box 3033, Lansvale NSW 2166, AUSTRALIA

112 Christina Rd, Villawood, NSW 2163

Phone: 1300 864 644

Fax: (02) 9780 4244

Email: sales@unimig.com.au

www.unimig.com.au

© Welding Guns Of Australia PTY LTD 2018