

UNIMIG



MIG TORCHES

Contents

1. Installation	3
1.1 BINZEL Style M15 Torch.....	3
1.2 BINZEL Style M24 Torch.....	4
1.3 BINZEL Style SB25 Torch.....	5
1.4 BINZEL Style SB36/38/500 Water-Cooled Torch.....	6
1.5 TWECO Style Torch - Adjustable Nozzle.....	7
1.6 TWECO Style Torch - Fixed Nozzle.....	8
1.7 Bernard Style Torch.....	9
2. MIG Torch & Consumables	10
2.1 M15 BINZEL Style MIG Torch.....	10
2.2 M15 BINZEL Style MIG Torch Consumables.....	11
2.3 M24 BINZEL Style MIG Torch.....	12
2.4 M24 BINZEL Style MIG Torch Consumables.....	13
2.5 M24 BINZEL Style Digital MIG Torch.....	14
2.6 M24 BINZEL Style Digital MIG Torch Consumables.....	15
2.7 SB25 BINZEL Style MIG Torch.....	16
2.8 SB25 BINZEL Style MIG Torch Consumables.....	17
2.9 SB36 BINZEL Style MIG Torch.....	18
2.10 SB36 BINZEL Style MIG Torch Consumables.....	19
2.11 SB38 BINZEL Style MIG Torch.....	20
2.12 SB38 BINZEL Style MIG Torch Consumables.....	21
2.13 SB500 Water-Cooled BINZEL Style MIG Torch.....	22
2.14 SB500 Water-Cooled BINZEL Style MIG Torch Consumables.....	23
2.15 M26 BINZEL Style Digital MIG Torch.....	24
2.16 M26 BINZEL Style Digital MIG Torch Consumables.....	25
2.17 TWC2 Tweco Style MIG Torch.....	26
2.18 TWC2 Tweco Style MIG Torch Consumables.....	27
2.18.1 Adjustable Nozzle.....	27
2.18.2 Fixed Nozzle.....	28
2.19 TWC4 Tweco Style MIG Torch.....	29
2.20 TWC4 Tweco Style MIG Torch Consumables.....	30
2.20.1 Adjustable Nozzle.....	30
2.20.2 Fixed Nozzle.....	31
2.21 TWC5 Tweco Style MIG Torch.....	32
2.22 TWC5 Tweco Style MIG Torch Consumables.....	33
2.23 BND300 Bernard Style MIG Torch.....	34
2.24 BND300 Bernard Style MIG Torch Consumables.....	35
2.25 BND400 Bernard Style MIG Torch.....	36
2.26 BND400 Bernard Style MIG Torch Consumables.....	37

1. Installation

1.1 BINZEL Style M15 Torch

1. Screw the tip holder into the torch neck. Fasten securely.

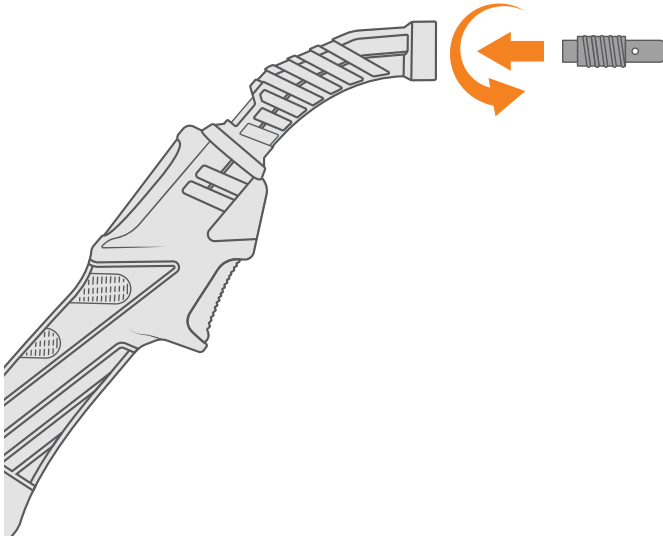

2. Screw the contact tip into the tip holder. Fasten securely.

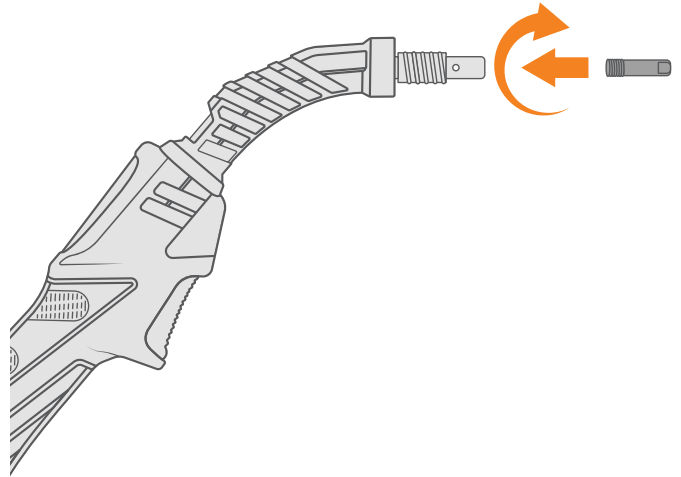

3. Slide on the gas nozzle over the tip holder to complete the torch. Twisting the nozzle can aid in getting the gas nozzle on securely.

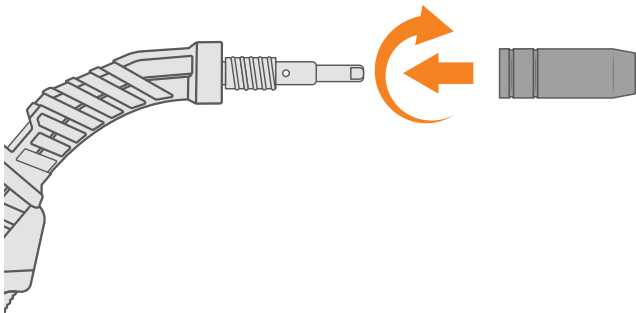

1.2 BINZEL Style M24 Torch

1. Place the gas diffuser onto the torch neck.

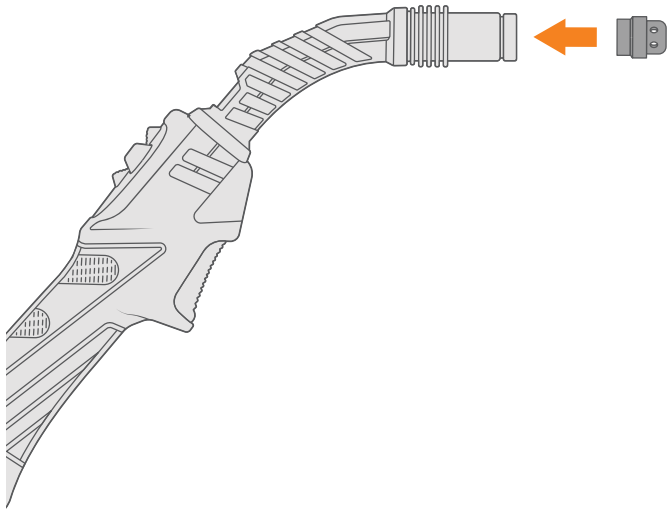

2. Screw in the tip holder into the torch neck, locking the gas diffuser in place. Fasten securely

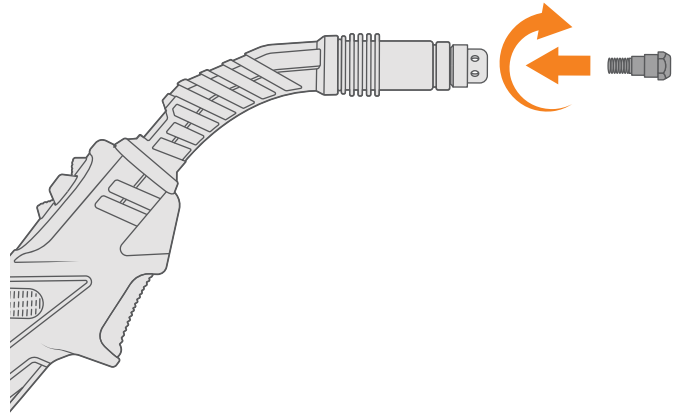

3. Screw the contact tip into the tip holder. Fasten securely.

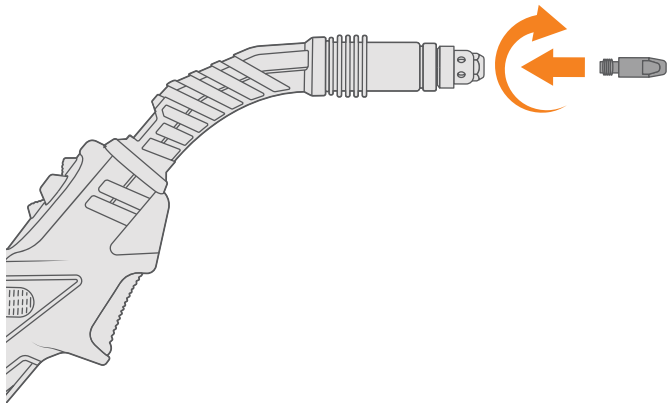

4. Slide on the gas nozzle over the tip holder to complete the torch. Twisting the nozzle can aid in getting the gas nozzle on securely.

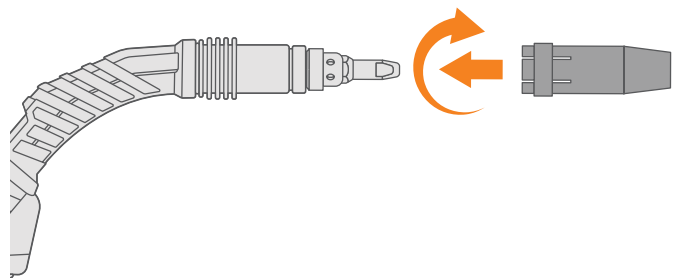

1.3 BINZEL Style SB25 Torch

1. Screw the tip holder into the torch neck. Fasten securely.

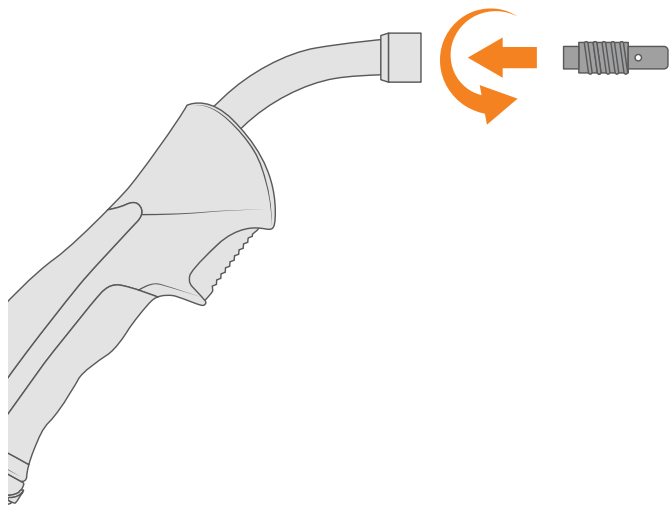

2. Screw the contact tip into the tip holder. Fasten securely.

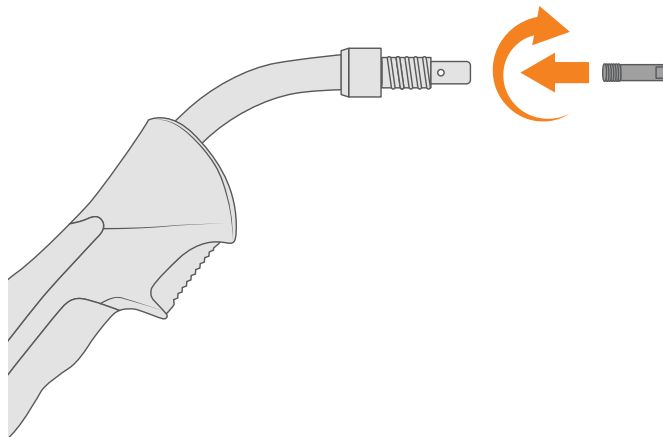

3. Slide on the gas nozzle over the tip holder to complete the torch. Twisting the nozzle can aid in getting the gas nozzle on securely.

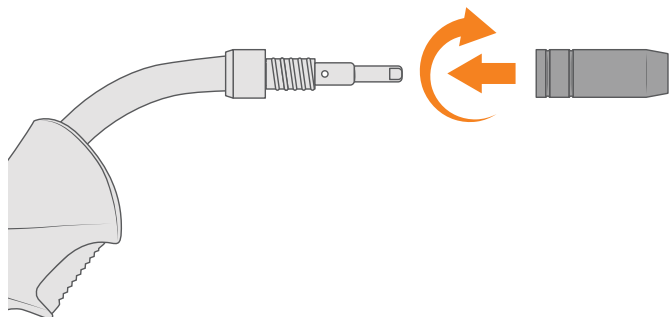

1.4 BINZEL Style SB36/38/500 Water-Cooled Torch

1. Place the gas diffuser onto the torch neck.

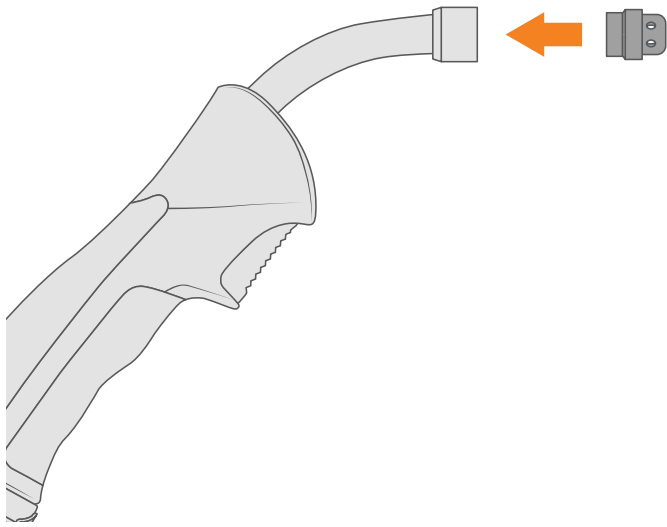

2. Screw in the tip holder into the torch neck, locking the gas diffuser in place. Fasten securely

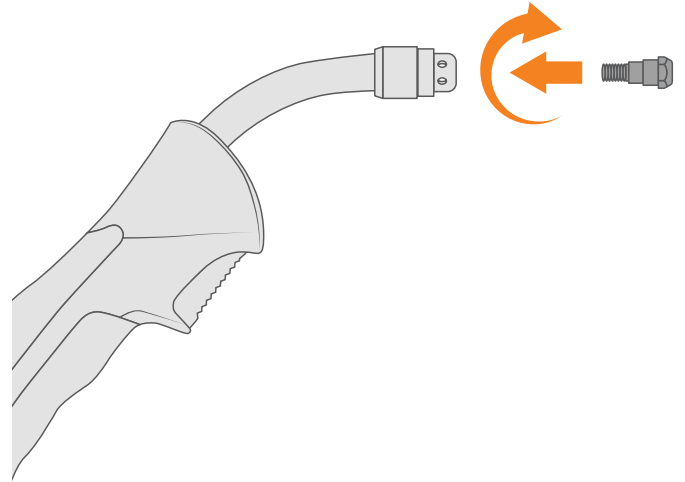

3. Screw the contact tip into the tip holder. Fasten securely.

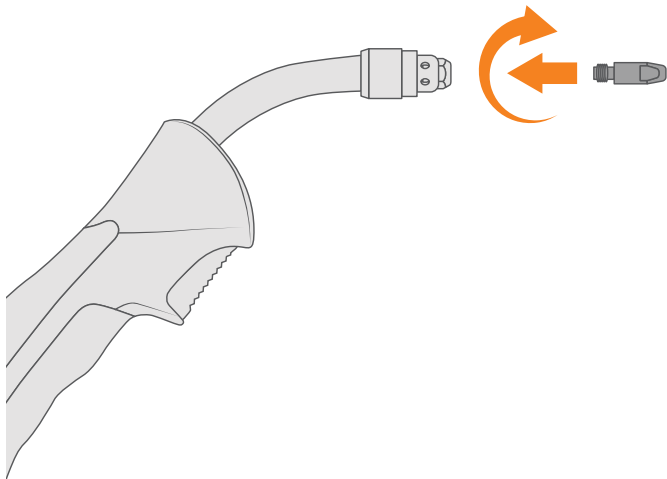

4. Slide on the gas nozzle over the tip holder to complete the torch. Twisting the nozzle can aid in getting the gas nozzle on securely.

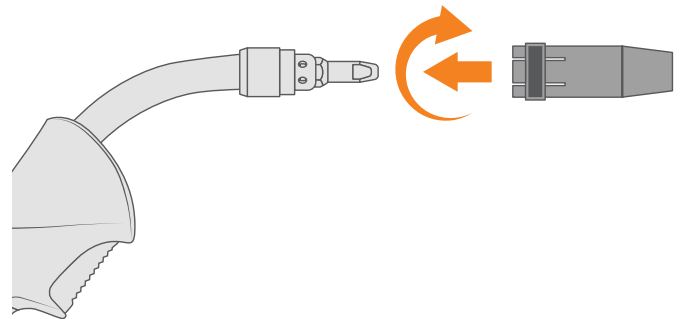

1.5 TWECO Style Torch - Adjustable Nozzle

1. Screw the adjustable gas diffuser into the torch neck. Fasten securely.

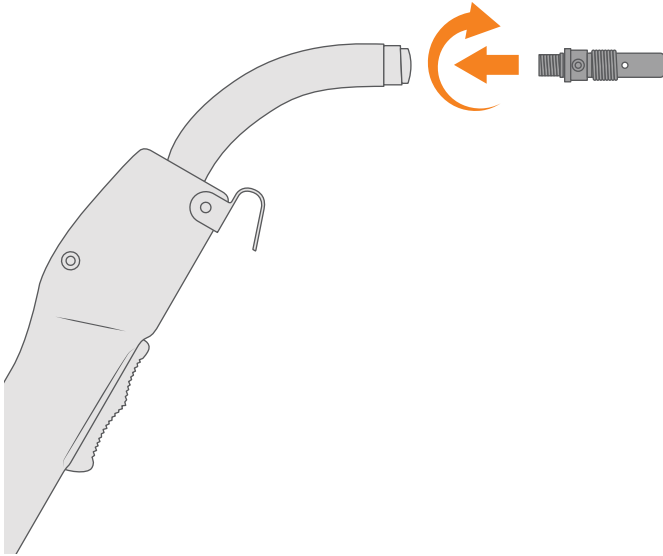

2. Screw the contact tip into the adjustable gas diffuser. Fasten securely.

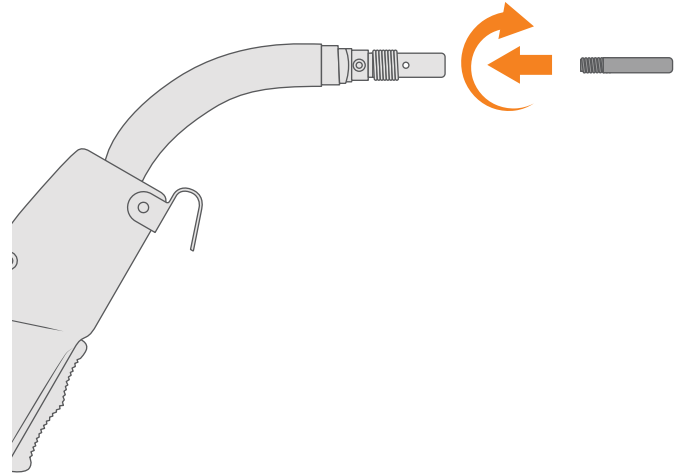

3. Screw the adjustable nozzle insulator on to the adjustable gas diffuser. Fasten securely.

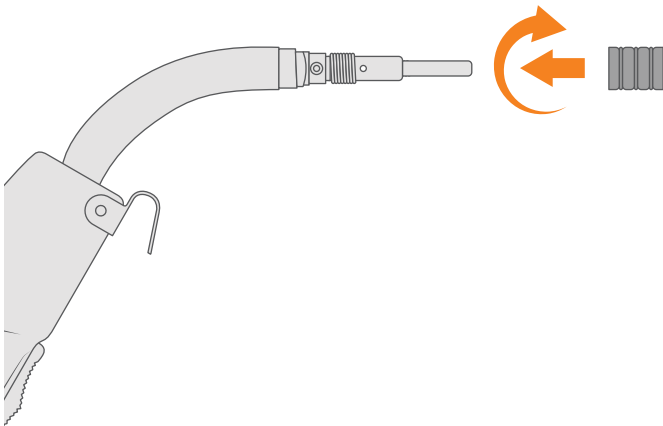

4. Slide the adjustable gas nozzle over the adjustable gas diffuser. Twisting the nozzle can aid in getting the gas nozzle on securely.

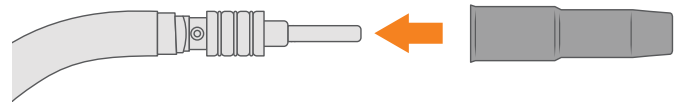

1.6 TWECO Style Torch - Fixed Nozzle

1. Screw the tip holder into the torch neck. Fasten securely.

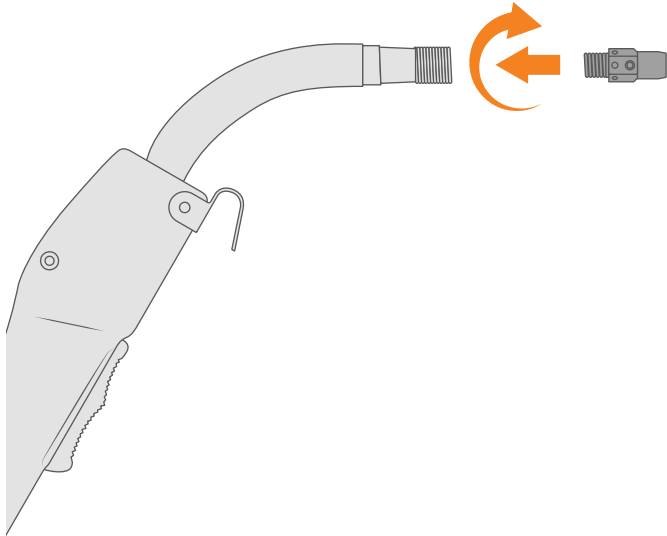

2. Screw the contact tip into the tip holder. Fasten securely.

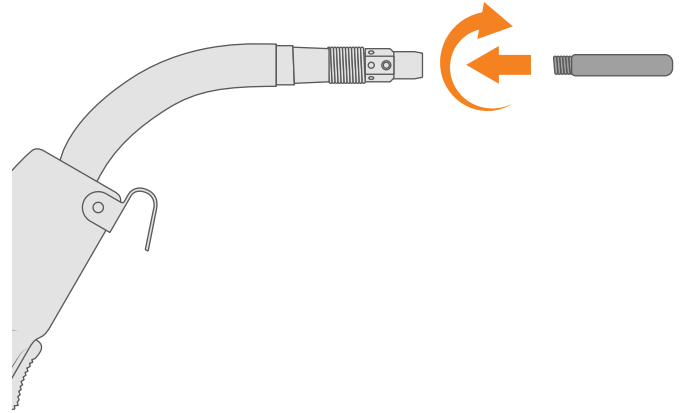

3. Screw the nozzle insulator on to the tip holder. Fasten securely.

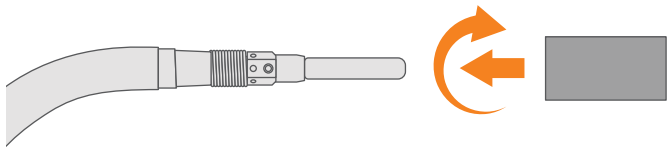

4. Screw the gas nozzle onto the nozzle insulator. Fasten securely.

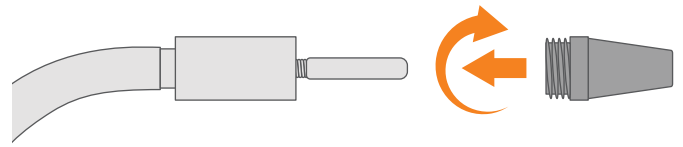

1.7 Bernard Style Torch

1. Place the rubber cap onto the torch neck.

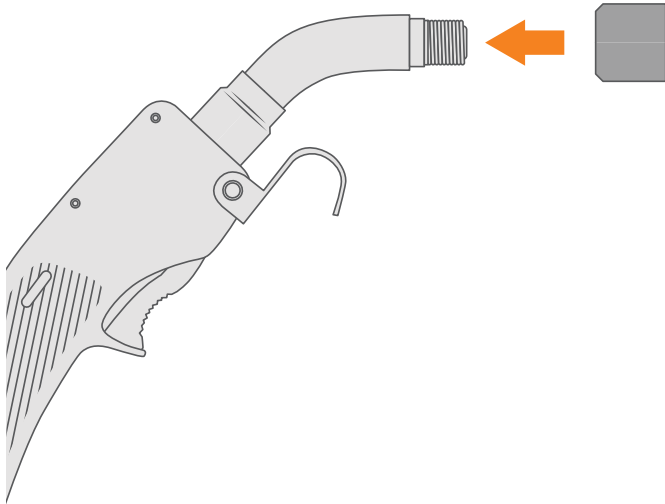

2. Screw the head assembly onto the torch neck. Fasten securely.

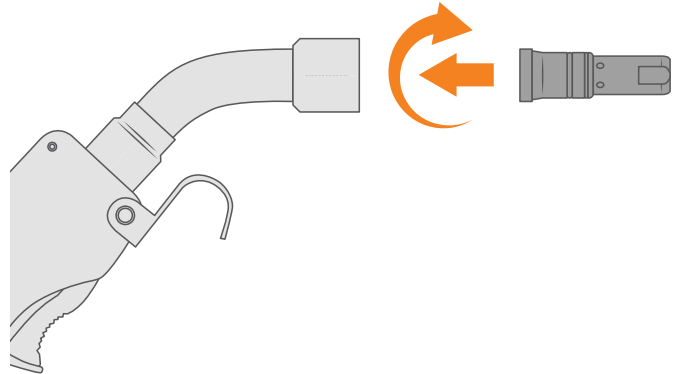

3. Screw the contact tip into the head assembly. Fasten securely.

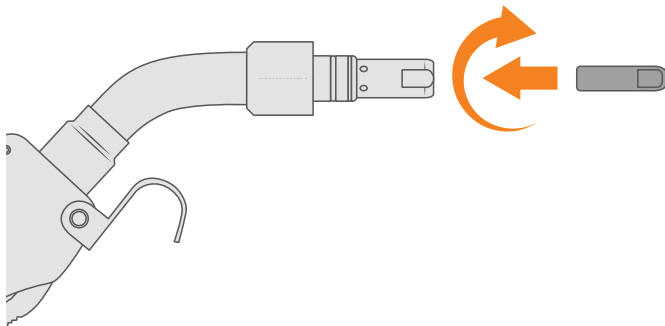

4. Slide the gas nozzle over the head assembly. Twisting the nozzle can aid in getting the gas nozzle on securely.

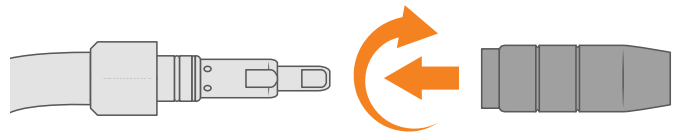

2. MIG Torch & Consumables

2.1 M15 BINZEL Style MIG Torch

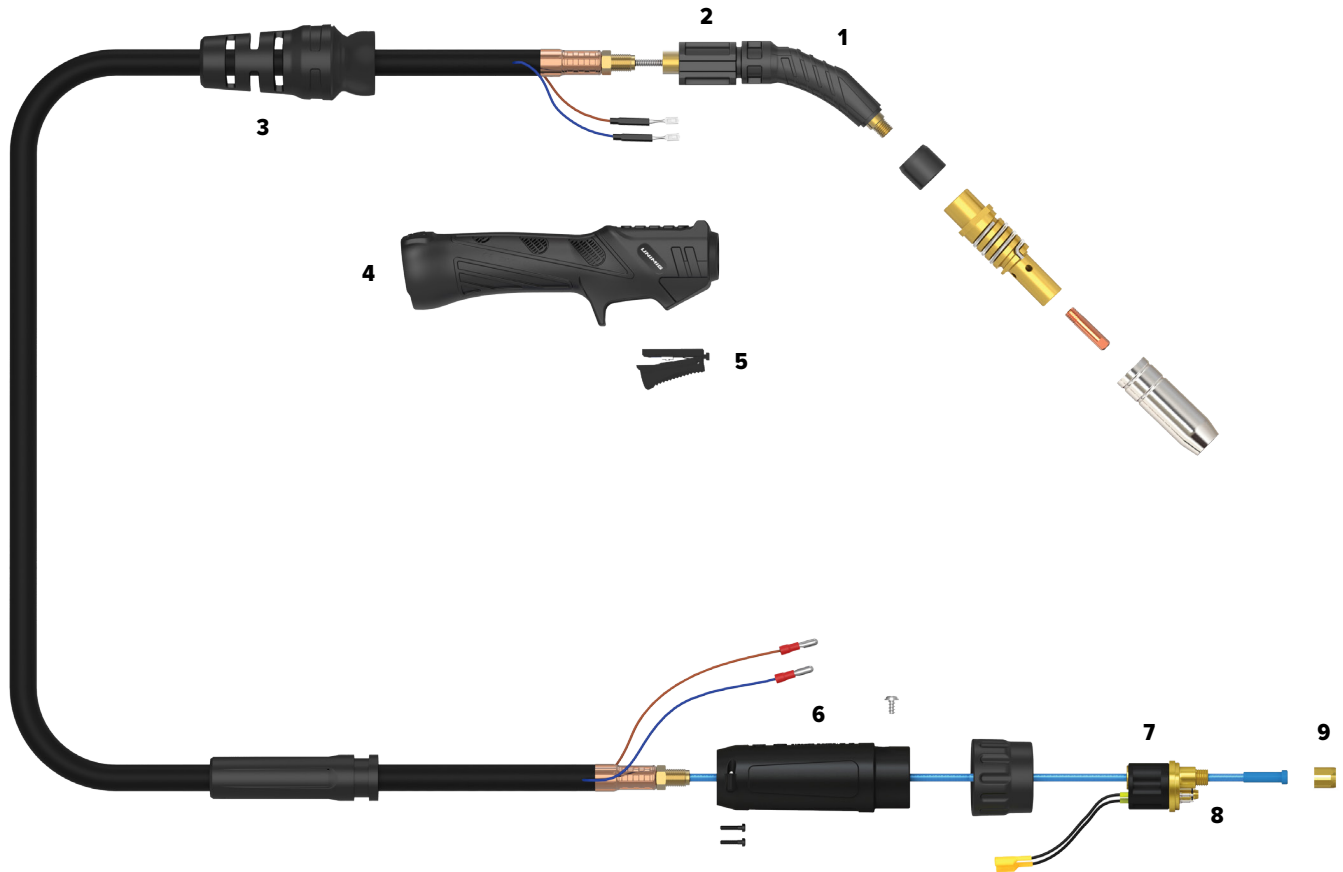

Length	3m	4m	5m
SKU	U41004	U41005	U41006

1	U41012	SWAN NECK SUIT M15
2	AM1505	LOCK NUT
3	AM1514-BK	HANDLE CABLE SUPPORT C/W BALL JOINT
4	AM2514	HANDLE KIT
5	AM2516-BK	STANDARD TRIGGER
6	AM2578/S	GUN PLUG HOUSING
7	UC1528	HYBRID GUN PLUG BODY C/W SPRING PINS
8	UB1524	GUN PLUG 'O' RING
9	UB1525	LINER NUT

COOLING METHOD	Air-Cooled
DUTY CYCLE - CO2	60% @ 180A
DUTY CYCLE - MIXED GAS	60% @ 150A
WIRE SIZE	0.6-1.0mm
STANDARD	EN60974-7

2.2 M15 BINZEL Style MIG Torch Consumables



Tip Holder

PCTH15	TIP HOLDER SUIT M15 QTY2
---------------	--------------------------

Nozzle Spring

PGNS15	NOZZLE SPRING SUIT M15 QTY2
---------------	-----------------------------

Contact Tip

PCTAL0008-09	CONTACT TIPS ALUMINIUM BINZEL STYLE 0.9MM QTY 10
PCTAL0008-10	CONTACT TIPS ALUMINIUM BINZEL STYLE 1.0MM QTY 10
PCTAL0008-12	CONTACT TIPS ALUMINIUM BINZEL STYLE 1.2MM QTY 10
PCT0008-06	CONTACT TIPS BINZEL STYLE 0.6MM QTY 10
PCT0008-08	CONTACT TIPS BINZEL STYLE 0.8MM QTY 10
PCT0008-09	CONTACT TIPS BINZEL STYLE 0.9MM QTY 10
PCT0008-10	CONTACT TIPS BINZEL STYLE 1.0MM QTY 10
PCT0008-12	CONTACT TIPS BINZEL STYLE 1.2MM QTY 10

Gas Nozzle

PGN15CON	GAS NOZZLE CONICAL SUIT M15 QTY 2
PGN15CYL	GAS NOZZLE CYLINDRICAL SUIT M15 QTY 2
PGN15SPOT	GAS NOZZLE SPOT SUIT M15 QTY 2
PGN15TAP	GAS NOZZLE TAPERED SUIT M15 QTY 2
PGN15GLN	GASLESS NOZZLE SUIT M15 QTY 2

Liners



TLB3M	LINER BINZEL STYLE ALUMINIUM BLUE 0.6-0.8MM 3M
TLB4M	LINER BINZEL STYLE ALUMINIUM BLUE 0.6-0.8MM 4M
TLR3M	LINER BINZEL STYLE ALUMINIUM RED 0.9-1.2MM 3M
TLR4M	LINER BINZEL STYLE ALUMINIUM RED 0.9-1.2MM 4M
SLB3M	LINER BINZEL STYLE STEEL BLUE 0.6-0.8MM 3M
SLB4M	LINER BINZEL STYLE STEEL BLUE 0.6-0.8MM 4M
SLB5M	LINER BINZEL STYLE STEEL BLUE 0.6-0.8MM 5M
SLR3M	LINER BINZEL STYLE STEEL RED 0.9-1.2MM 3M
SLR4M	LINER BINZEL STYLE STEEL RED 0.9-1.2MM 4M
SLR5M	LINER BINZEL STYLE STEEL RED 0.9-1.2MM 5M
NKSTL-3.5MM	NECK SPRING FOR ALUMINIUM

2.3 M24 BINZEL Style MIG Torch

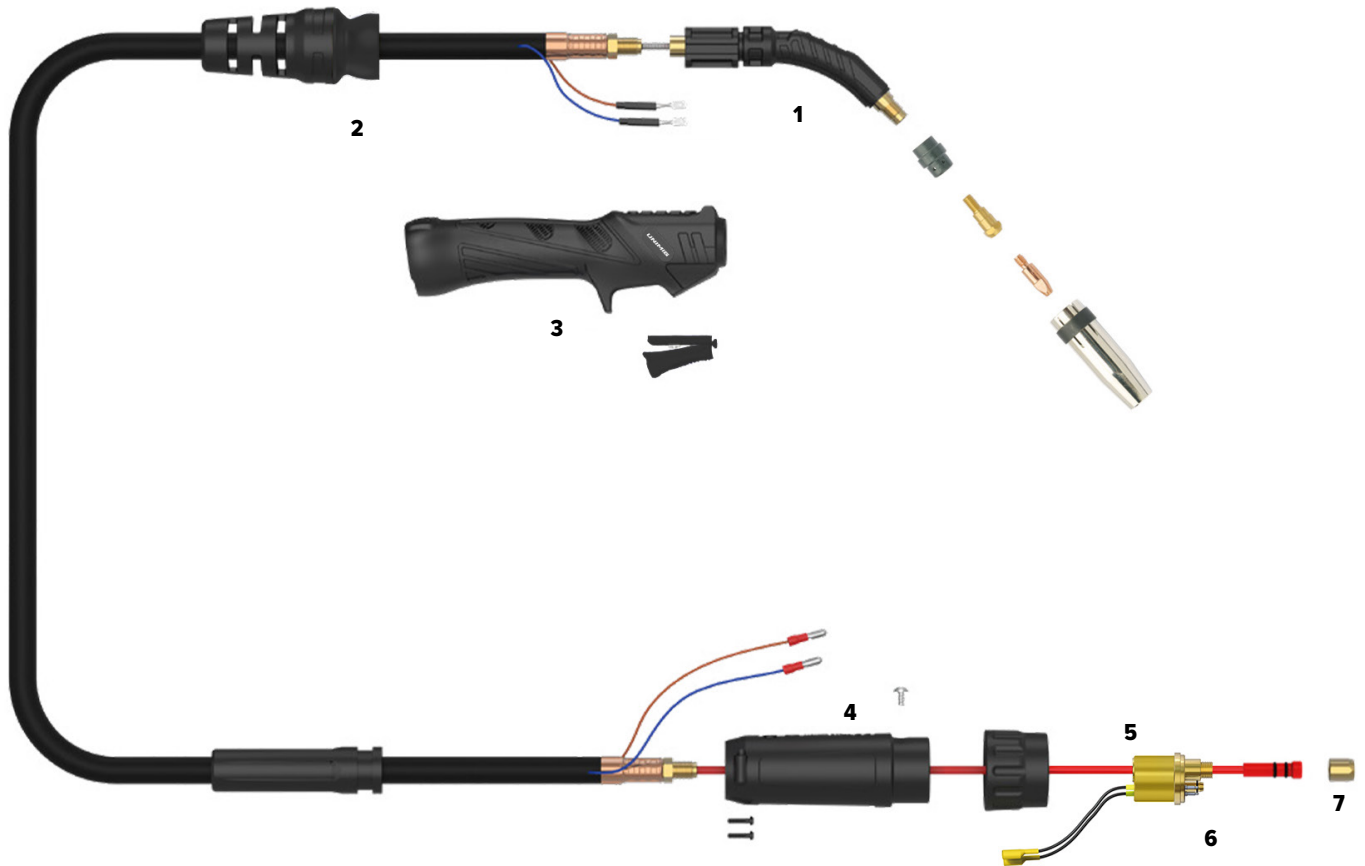

Length	3m	4m	5m
SKU	U41007	U41008	U41009

1	U41013	SWAN NECK SUIT M24	COOLING METHOD	Air-Cooled
2	AM1514-BK	HANDLE CABLE SUPPORT C/W BALL JOINT	DUTY CYCLE - CO2	60% @ 250A
3	AM2514	HANDLE KIT	DUTY CYCLE - MIXED GAS	60% @ 220A
4	AM2578/L	GUN PLUG HOUSING	WIRE SIZE	0.6-1.2mm
5	UB1528	GUN PLUG BODY C/W SPRING PINS	STANDARD	EN60974-7
6	UB1524	GUN PLUG 'O' RING		
7	UB1525	LINER NUT		

2.4 M24 BINZEL Style MIG Torch Consumables



Gas Diffuser

PCGD24	GAS DIFFUSER CERAMIC SUIT M24 QTY2
PCGD24R	GAS DIFFUSER RUBBER SUIT M24 QTY2
U11182	GAS DIFFUSER PLASTIC SUIT M24 QTY2

Tip Holder

PCTH24	TIP HOLDER SUIT M24 QTY 2
---------------	---------------------------

Contact Tip

PCTAL0009-09	CONTACT TIPS ALUMINIUM BINZEL STYLE M6 0.9MM QTY 10
PCTAL0009-10	CONTACT TIPS ALUMINIUM BINZEL STYLE M6 1.0MM QTY 10
PCTAL0009-12	CONTACT TIPS ALUMINIUM BINZEL STYLE M6 1.2MM QTY 10
PCT0009-06	CONTACT TIPS BINZEL STYLE M6 0.6MM QTY 10
PCT0009-08	CONTACT TIPS BINZEL STYLE M6 0.8MM QTY 10
PCT0009-09	CONTACT TIPS BINZEL STYLE M6 0.9MM QTY 10
PCT0009-10	CONTACT TIPS BINZEL STYLE M6 1.0MM QTY 10
PCT0009-12	CONTACT TIPS BINZEL STYLE M6 1.2MM QTY 10
PCT0009-16	CONTACT TIPS BINZEL STYLE M6 1.6MM QTY 10

Gas Nozzle

PGN24CON	GAS NOZZLE CONICAL SUIT M24 QTY 2
PGN24CYL	GAS NOZZLE CYLINDRICAL SUIT M24 QTY 2
PGN24TAP	GAS NOZZLE TAPERED SUIT M24 QTY 2

Liners



TLB3M	LINER BINZEL STYLE ALUMINIUM BLUE 0.6-0.8MM 3M
TLB4M	LINER BINZEL STYLE ALUMINIUM BLUE 0.6-0.8MM 4M
TLR3M	LINER BINZEL STYLE ALUMINIUM RED 0.9-1.2MM 3M
TLR4M	LINER BINZEL STYLE ALUMINIUM RED 0.9-1.2MM 4M
SLB3M	LINER BINZEL STYLE STEEL BLUE 0.6-0.8MM 3M
SLB4M	LINER BINZEL STYLE STEEL BLUE 0.6-0.8MM 4M
SLB5M	LINER BINZEL STYLE STEEL BLUE 0.6-0.8MM 5M
SLR3M	LINER BINZEL STYLE STEEL RED 0.9-1.2MM 3M
SLR4M	LINER BINZEL STYLE STEEL RED 0.9-1.2MM 4M
SLR5M	LINER BINZEL STYLE STEEL RED 0.9-1.2MM 5M
NKSTL-3.5MM	NECK SPRING FOR ALUMINIUM

2.5 M24 BINZEL Style Digital MIG Torch

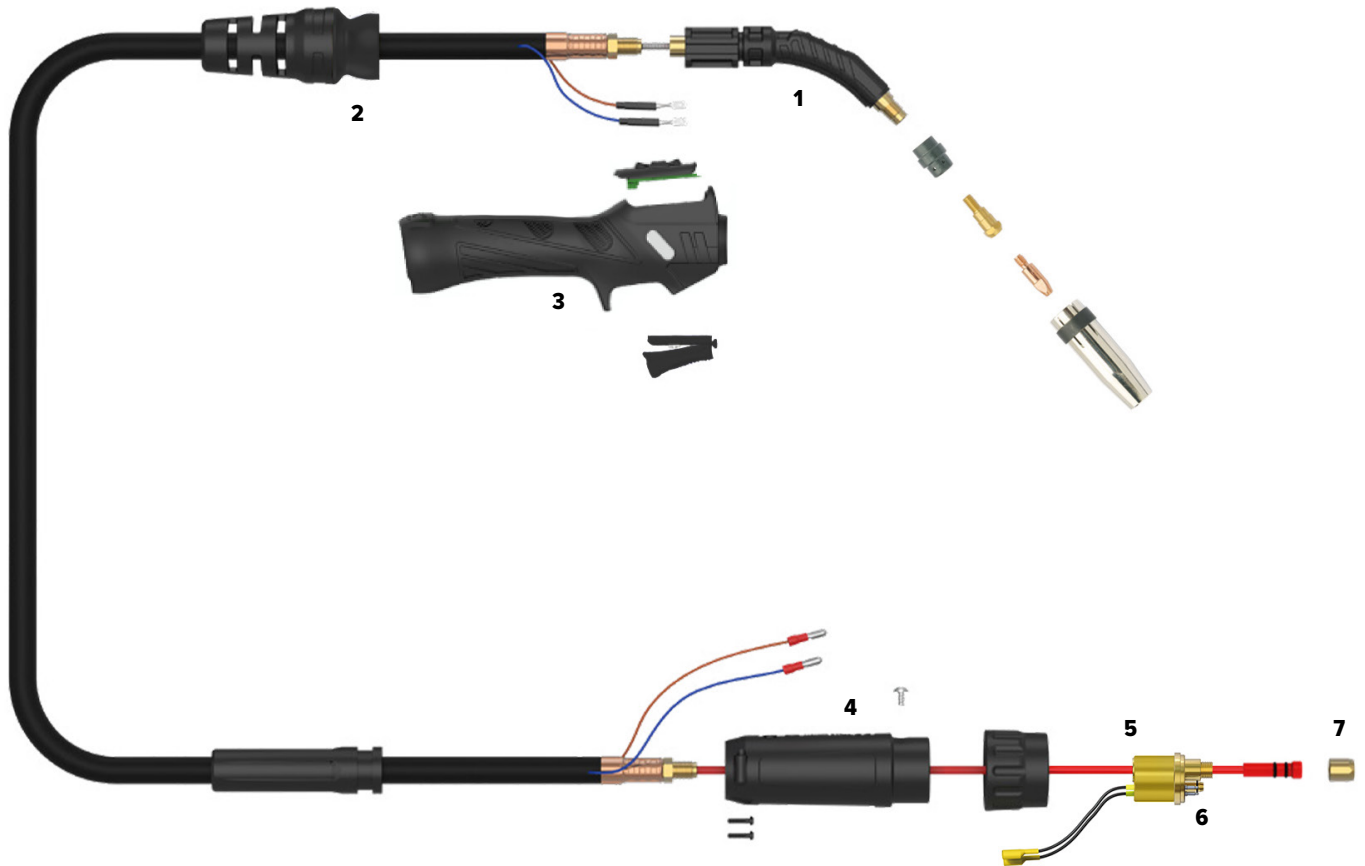

Length	3m	4m
SKU	U41010	U41011

1	U41013	SWAN NECK SUIT M24
2	AM1514-BK	HANDLE CABLE SUPPORT C/W BALL JOINT
3	AMM2514-KJ	HANDLE KIT
4	AM2578/L	GUN PLUG HOUSING
5	UB1528	GUN PLUG BODY C/W SPRING PINS
6	UB1524	GUN PLUG 'O' RING
7	UB1525	LINER NUT

COOLING METHOD	Air-Cooled
DUTY CYCLE - CO2	60% @ 250A
DUTY CYCLE - MIXED GAS	60% @ 220A
WIRE SIZE	0.6-1.2mm
STANDARD	EN60974-7

2.6 M24 BINZEL Style Digital MIG Torch Consumables



Gas Diffuser

PCGD24	GAS DIFFUSER CERAMIC SUIT M24 QTY2
PCGD24R	GAS DIFFUSER RUBBER SUIT M24 QTY2
U11182	GAS DIFFUSER PLASTIC SUIT M24 QTY2

Tip Holder

PCTH24	TIP HOLDER SUIT M24 QTY 2
---------------	---------------------------

Contact Tip

PCTAL0009-09	CONTACT TIPS ALUMINIUM BINZEL STYLE M6 0.9MM QTY 10
PCTAL0009-10	CONTACT TIPS ALUMINIUM BINZEL STYLE M6 1.0MM QTY 10
PCTAL0009-12	CONTACT TIPS ALUMINIUM BINZEL STYLE M6 1.2MM QTY 10
PCT0009-06	CONTACT TIPS BINZEL STYLE M6 0.6MM QTY 10
PCT0009-08	CONTACT TIPS BINZEL STYLE M6 0.8MM QTY 10
PCT0009-09	CONTACT TIPS BINZEL STYLE M6 0.9MM QTY 10
PCT0009-10	CONTACT TIPS BINZEL STYLE M6 1.0MM QTY 10
PCT0009-12	CONTACT TIPS BINZEL STYLE M6 1.2MM QTY 10
PCT0009-16	CONTACT TIPS BINZEL STYLE M6 1.6MM QTY 10

Gas Nozzle

PGN24CON	GAS NOZZLE CONICAL SUIT M24 QTY 2
PGN24CYL	GAS NOZZLE CYLINDRICAL SUIT M24 QTY 2
PGN24TAP	GAS NOZZLE TAPERED SUIT M24 QTY 2

Liners



TLB3M	LINER BINZEL STYLE ALUMINIUM BLUE 0.6-0.8MM 3M
TLB4M	LINER BINZEL STYLE ALUMINIUM BLUE 0.6-0.8MM 4M
TLR3M	LINER BINZEL STYLE ALUMINIUM RED 0.9-1.2MM 3M
TLR4M	LINER BINZEL STYLE ALUMINIUM RED 0.9-1.2MM 4M
SLB3M	LINER BINZEL STYLE STEEL BLUE 0.6-0.8MM 3M
SLB4M	LINER BINZEL STYLE STEEL BLUE 0.6-0.8MM 4M
SLB5M	LINER BINZEL STYLE STEEL BLUE 0.6-0.8MM 5M
SLR3M	LINER BINZEL STYLE STEEL RED 0.9-1.2MM 3M
SLR4M	LINER BINZEL STYLE STEEL RED 0.9-1.2MM 4M
SLR5M	LINER BINZEL STYLE STEEL RED 0.9-1.2MM 5M
NKSTL-3.5MM	NECK SPRING FOR ALUMINIUM

2.7 SB25 BINZEL Style MIG Torch

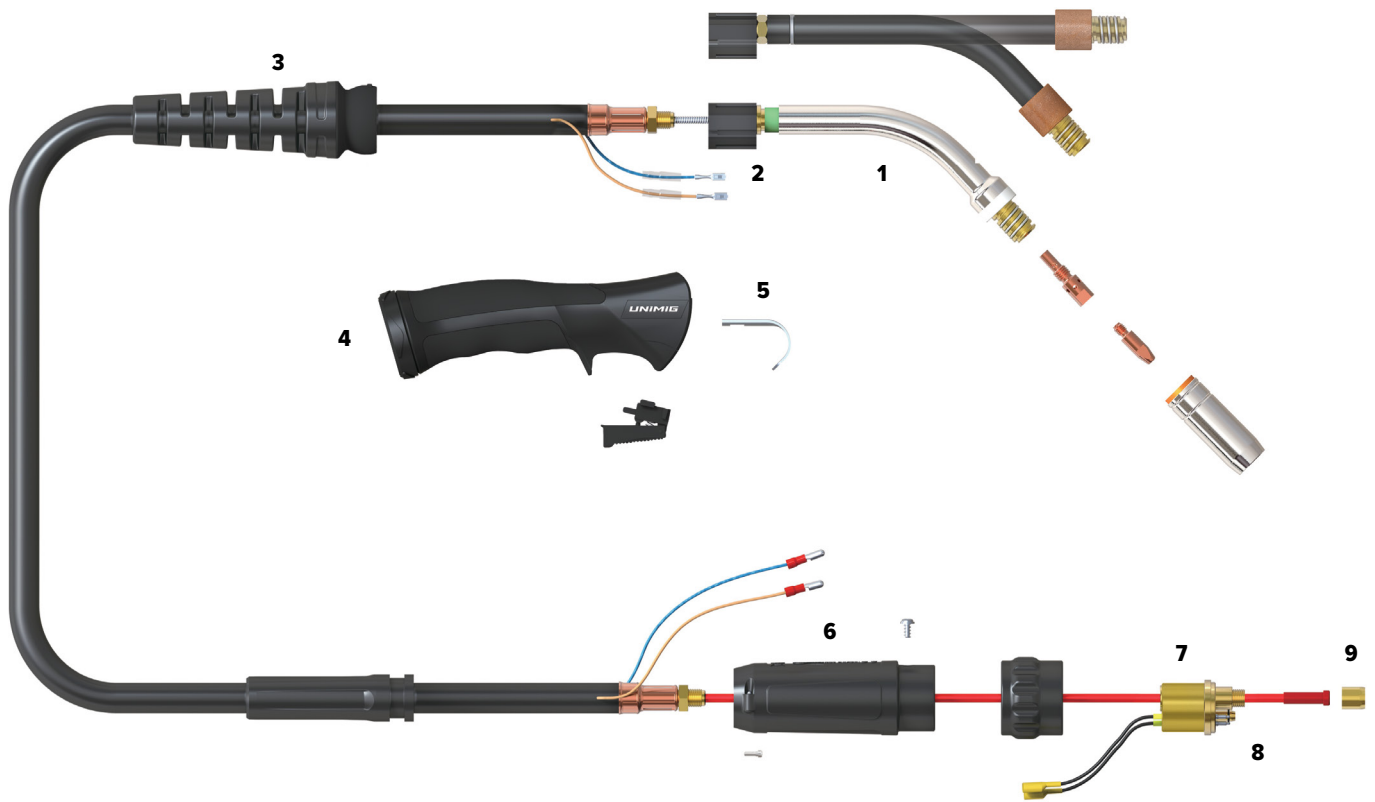

Length	3m	4m	5m
SKU	SB253M	SB254M	SB255M

1	SNK25	SWAN NECK SUIT SB25
2	UG1515	ERGO HANDLE LOCATION BODY
3	UG8015-BK	HANDLE CABLE SUPPORT C/W BALL JOINT
4	UG2514-BK	ERGO HANDLE KIT C/W LOCK NUT
5	UB2517	HANGER HOOK (OPTIONAL)
6	SC2578-S	GUN PLUG HOUSING
7	UB1528	GUN PLUG BODY C/W SPRING PINS
8	UB1524	GUN PLUG 'O' RING
9	UB1525	LINER NUT

COOLING METHOD	Air-Cooled
DUTY CYCLE - CO2	60% @ 230A
DUTY CYCLE - MIXED GAS	60% @ 200A
WIRE SIZE	0.6-1.2mm
STANDARD	EN60974-7

2.8 SB25 BINZEL Style MIG Torch Consumables



Nozzle Spring

PGNS25	NOZZLE SPRING SUIT SB25 QTY2
---------------	------------------------------

Tip Holder

PCTH25	TIP HOLDER SUIT SB25 QTY 2
---------------	----------------------------

Contact Tip

PCTAL0009-09	CONTACT TIPS ALUMINIUM BINZEL STYLE M6 0.9MM QTY 10
PCTAL0009-10	CONTACT TIPS ALUMINIUM BINZEL STYLE M6 1.0MM QTY 10
PCTAL0009-12	CONTACT TIPS ALUMINIUM BINZEL STYLE M6 1.2MM QTY 10
PCT0009-06	CONTACT TIPS BINZEL STYLE M6 0.6MM QTY 10
PCT0009-08	CONTACT TIPS BINZEL STYLE M6 0.8MM QTY 10
PCT0009-09	CONTACT TIPS BINZEL STYLE M6 0.9MM QTY 10
PCT0009-10	CONTACT TIPS BINZEL STYLE M6 1.0MM QTY 10
PCT0009-12	CONTACT TIPS BINZEL STYLE M6 1.2MM QTY 10

Gas Nozzle

PGN25CON	GAS NOZZLE CONICAL SUIT SB25 QTY 2
PGN25CYL	GAS NOZZLE CYLINDRICAL SUIT SB25 QTY 2
PGN25SPOT	GAS NOZZLE SPOT SUIT SB25 QTY 2

Liners



TLB3M	LINER BINZEL STYLE ALUMINIUM BLUE 0.6-0.8MM 3M
TLB4M	LINER BINZEL STYLE ALUMINIUM BLUE 0.6-0.8MM 4M
TLR3M	LINER BINZEL STYLE ALUMINIUM RED 0.9-1.2MM 3M
TLR4M	LINER BINZEL STYLE ALUMINIUM RED 0.9-1.2MM 4M
SLB3M	LINER BINZEL STYLE STEEL BLUE 0.6-0.8MM 3M
SLB4M	LINER BINZEL STYLE STEEL BLUE 0.6-0.8MM 4M
SLB5M	LINER BINZEL STYLE STEEL BLUE 0.6-0.8MM 5M
SLR3M	LINER BINZEL STYLE STEEL RED 0.9-1.2MM 3M
SLR4M	LINER BINZEL STYLE STEEL RED 0.9-1.2MM 4M
SLR5M	LINER BINZEL STYLE STEEL RED 0.9-1.2MM 5M
NKSTL-3.5MM	NECK SPRING FOR ALUMINIUM

2.9 SB36 BINZEL Style MIG Torch

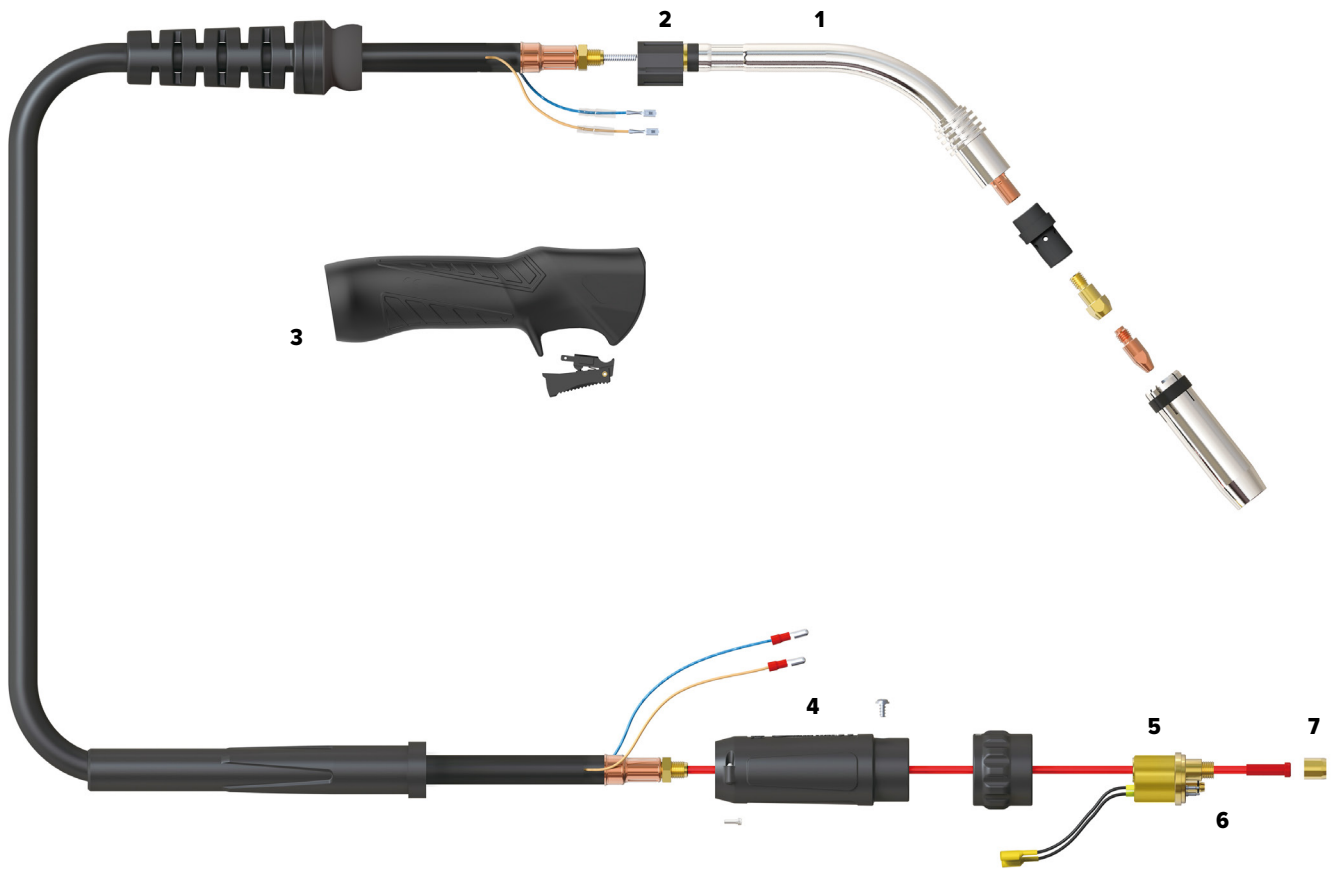

Length	3m	4m	5m
SKU	SB363M	SB364M	SB365M

1	SNK36	SWAN NECK SUIT SB36
2	UG1515	ERGO HANDLE LOCATION BODY
3	UEVG2514-KJ-BK	HANDLE KIT
4	SC2578-L	GUN PLUG HOUSING
5	UB1528	GUN PLUG BODY C/W SPRING PINS
6	UB1524	GUN PLUG 'O' RING
7	UB1525	LINER NUT

COOLING METHOD	Air-Cooled
DUTY CYCLE - CO2	60% @ 320A
DUTY CYCLE - MIXED GAS	60% @ 290A
WIRE SIZE	0.8-1.2mm
STANDARD	EN60974-7

2.10 SB36 BINZEL Style MIG Torch Consumables



Gas Diffuser

PCGD36	GAS DIFFUSER CERAMIC SUIT SB36 QTY 2
U11183	GAS DIFFUSER PLASTIC SUIT SB36 QTY2

Tip Holder

PCTH36M6L	TIP HOLDER LONG SUIT SB36 M6 QTY 2
PCTH36M8L	TIP HOLDER LONG SUIT SB36 M6 QTY 2
PCTH36M6S	TIP HOLDER SHORT SUIT SB36 M8 QTY 2
PCTH36M8S	TIP HOLDER SHORT SUIT SB36 M8 QTY 2

Contact Tip

PCTAL0009-09	CONTACT TIPS ALUMINIUM BINZEL STYLE M6 0.9MM QTY 10
PCTAL0009-10	CONTACT TIPS ALUMINIUM BINZEL STYLE M6 1.0MM QTY 10
PCTAL0009-12	CONTACT TIPS ALUMINIUM BINZEL STYLE M6 1.2MM QTY 10
PCT0009-06	CONTACT TIPS BINZEL STYLE M6 0.6MM QTY 10
PCT0009-08	CONTACT TIPS BINZEL STYLE M6 0.8MM QTY 10
PCT0009-09	CONTACT TIPS BINZEL STYLE M6 0.9MM QTY 10
PCT0009-10	CONTACT TIPS BINZEL STYLE M6 1.0MM QTY 10
PCT0009-12	CONTACT TIPS BINZEL STYLE M6 1.2MM QTY 10
PCT0009-16	CONTACT TIPS BINZEL STYLE M6 1.6MM QTY 10
PCTAL0005-08	CONTACT TIPS ALUMINIUM BINZEL STYLE M8 0.8MM QTY 10
PCTAL0005-09	CONTACT TIPS ALUMINIUM BINZEL STYLE M8 0.9MM QTY 10
PCTAL0005-10	CONTACT TIPS ALUMINIUM BINZEL STYLE M8 1.0MM QTY 10
PCTAL0005-12	CONTACT TIPS ALUMINIUM BINZEL STYLE M8 1.2MM QTY 10
PCTAL0005-16	CONTACT TIPS ALUMINIUM BINZEL STYLE M8 1.6MM QTY 10
PCT0005-08	CONTACT TIPS BINZEL STYLE M8 0.8MM QTY 10
PCT0005-09	CONTACT TIPS BINZEL STYLE M8 0.9MM QTY 10
PCT0005-10	CONTACT TIPS BINZEL STYLE M8 1.0MM QTY 10
PCT0005-12	CONTACT TIPS BINZEL STYLE M8 1.2MM QTY 10

Gas Nozzle

PGN36CON	GAS NOZZLE CONICAL SUIT SB36 QTY 2
PGN36CYL	GAS NOZZLE CYLINDRICAL SUIT SB36 QTY 2
PGN36TAP	GAS NOZZLE TAPERED SUIT SB36 QTY 2

Liners

TLB3M	LINER BINZEL STYLE ALUMINIUM BLUE 0.6-0.8MM 3M
TLB4M	LINER BINZEL STYLE ALUMINIUM BLUE 0.6-0.8MM 4M
TLR3M	LINER BINZEL STYLE ALUMINIUM RED 0.9-1.2MM 3M
TLR4M	LINER BINZEL STYLE ALUMINIUM RED 0.9-1.2MM 4M
SLB3M	LINER BINZEL STYLE STEEL BLUE 0.6-0.8MM 3M
SLB4M	LINER BINZEL STYLE STEEL BLUE 0.6-0.8MM 4M
SLB5M	LINER BINZEL STYLE STEEL BLUE 0.6-0.8MM 5M
SLR3M	LINER BINZEL STYLE STEEL RED 0.9-1.2MM 3M
SLR4M	LINER BINZEL STYLE STEEL RED 0.9-1.2MM 4M
SLR5M	LINER BINZEL STYLE STEEL RED 0.9-1.2MM 5M
NKSTL-3.5MM	NECK SPRING FOR ALUMINIUM

2.11 SB38 BINZEL Style MIG Torch

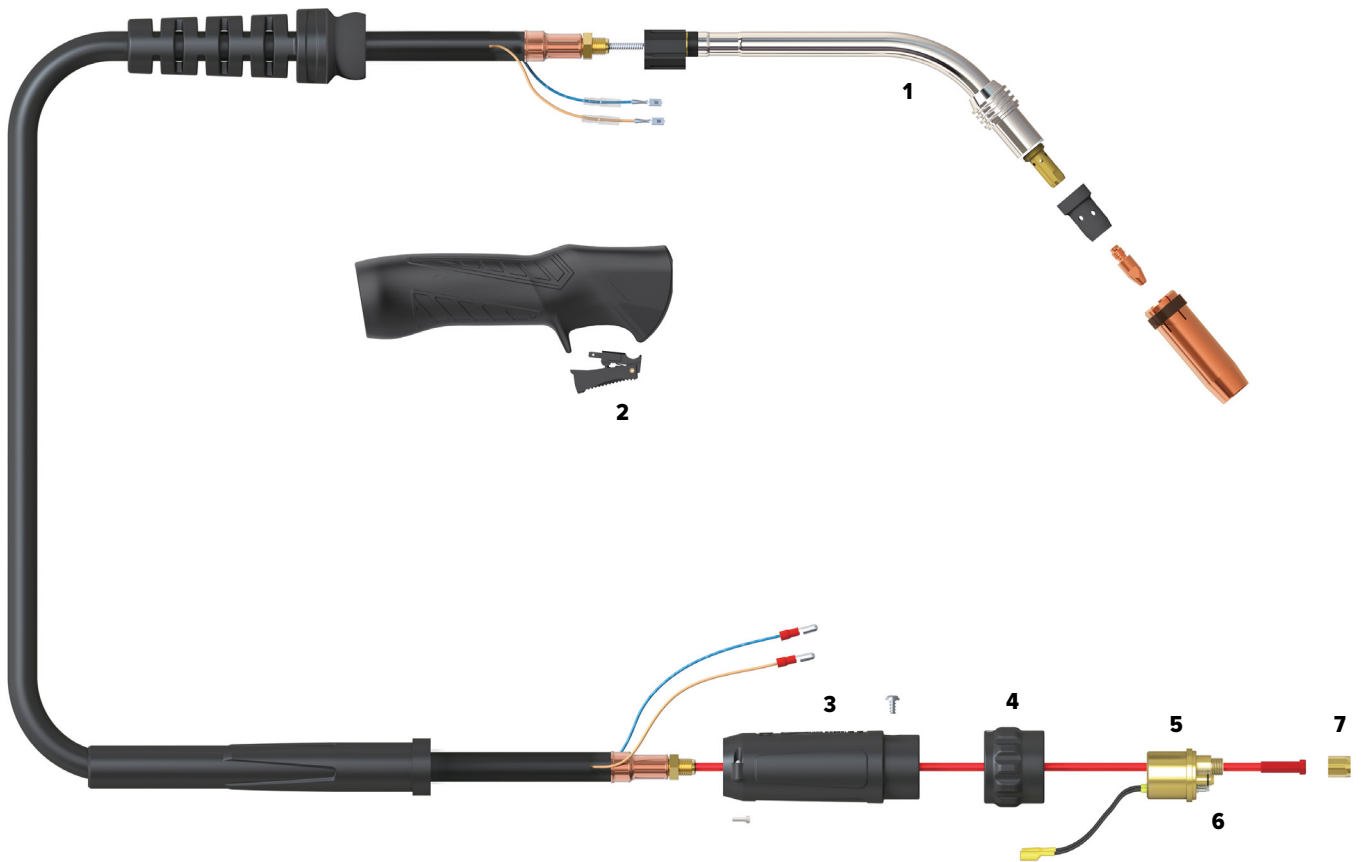

Length	3m	4m
SKU	SB38-3M	SB38-4M

1	SNK38	SWAN NECK SUIT SB38
2	UEVG2516-BK	EVO PRO STANDARD TRIGGER ASSY (BLACK)
3	SC2578-L	GUN PLUG BODY HOUSING
4	UC1519/S	GUN PLUG NUT
5	UB1528	GUN PLUG BODY C/W SPRING PINS
6	UB1524	GUN PLUG 'O' RING
7	UB1525	LINER NUT

COOLING METHOD	Air-Cooled
DUTY CYCLE - CO2	60% @ 350A
DUTY CYCLE - MIXED GAS	60% @ 320A
WIRE SIZE	1.0-1.6mm
STANDARD	EN60974-7

2.12 SB38 BINZEL Style MIG Torch Consumables



Tip Holder

PCTH38	TIP HOLDER SHORT SUIT SB38 M8 QTY 2
---------------	-------------------------------------

Gas Diffuser

PCGD38	GAS DIFFUSER SUIT SB38 QTY 2
U1185	GAS DIFFUSER PLASTIC SUIT SB38 QTY2

Contact Tip

PCTAL0005-08	CONTACT TIPS ALUMINIUM BINZEL STYLE M8 0.8MM QTY 10
PCTAL0005-09	CONTACT TIPS ALUMINIUM BINZEL STYLE M8 0.9MM QTY 10
PCTAL0005-10	CONTACT TIPS ALUMINIUM BINZEL STYLE M8 1.0MM QTY 10
PCTAL0005-12	CONTACT TIPS ALUMINIUM BINZEL STYLE M8 1.2MM QTY 10
PCTAL0005-16	CONTACT TIPS ALUMINIUM BINZEL STYLE M8 1.6MM QTY 10
PCT0005-08	CONTACT TIPS BINZEL STYLE M8 0.8MM QTY 10
PCT0005-09	CONTACT TIPS BINZEL STYLE M8 0.9MM QTY 10
PCT0005-10	CONTACT TIPS BINZEL STYLE M8 1.0MM QTY 10
PCT0005-12	CONTACT TIPS BINZEL STYLE M8 1.2MM QTY 10

Gas Nozzle

PGN38CYL	GAS NOZZLE CYLINDRICAL SUIT SB38 QTY 2
PGN38CON	GAS NOZZLE CONICAL SUIT SB38 QTY 2

Liners

SLB3M	LINER BINZEL STYLE STEEL BLUE 0.6-0.8MM 3M
SLB4M	LINER BINZEL STYLE STEEL BLUE 0.6-0.8MM 4M
SLB5M	LINER BINZEL STYLE STEEL BLUE 0.6-0.8MM 5M
SLR3M	LINER BINZEL STYLE STEEL RED 0.9-1.2MM 3M
SLR4M	LINER BINZEL STYLE STEEL RED 0.9-1.2MM 4M
SLR5M	LINER BINZEL STYLE STEEL RED 0.9-1.2MM 5M
SLY3M	LINER BINZEL STYLE STEEL YELLOW 1.2-1.6MM 3M
SLY4M	LINER BINZEL STYLE STEEL YELLOW 1.2-1.6MM 4M
SLY5M	LINER BINZEL STYLE STEEL YELLOW 1.2-1.6MM 5M
TLB3M	LINER BINZEL STYLE ALUMINIUM BLUE 0.6-0.8MM 3M
TLB4M	LINER BINZEL STYLE ALUMINIUM BLUE 0.6-0.8MM 4M
TLR3M	LINER BINZEL STYLE ALUMINIUM RED 0.9-1.2MM 3M
TLR4M	LINER BINZEL STYLE ALUMINIUM RED 0.9-1.2MM 4M
TLY3M	LINER BINZEL STYLE ALUMINIUM YELLOW 1.2-1.6MM 3M
TLY4M	LINER BINZEL STYLE ALUMINIUM YELLOW 1.2-1.6MM 4M
NKSTL-3.5MM	NECK SPRING FOR ALUMINIUM

2.13 SB500 Water-Cooled BINZEL Style MIG Torch

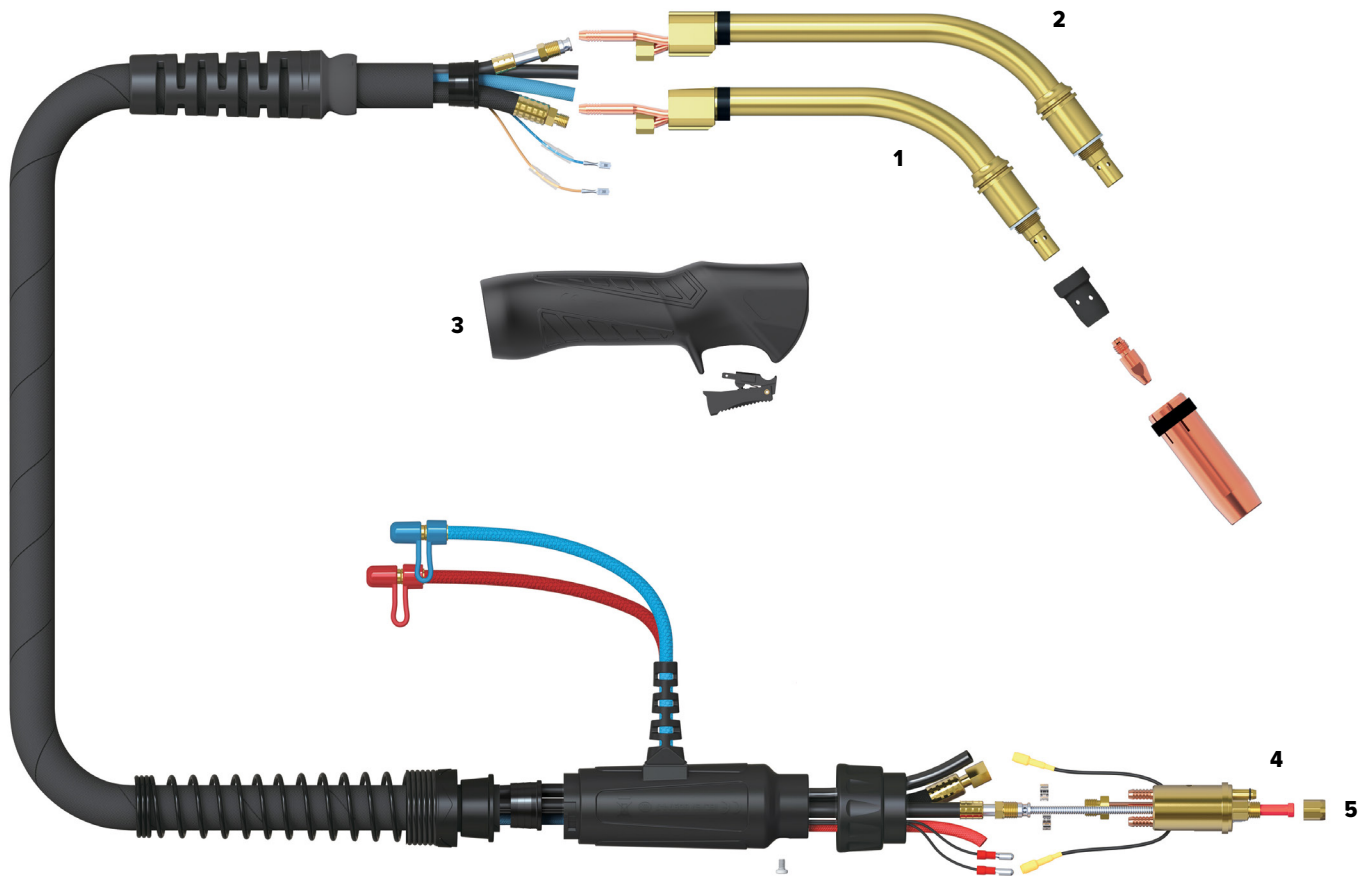

Length	3m	4m
SKU	SB500-3M	SB500-4M

1	SNK500	SWAN NECK SUIT SB500
2	UG5002L	SWAN NECK LONG SUIT SB500
3	UEVG2514-KJ-BK	HANDLE KIT
4	UB1524	GUN PLUG 'O' RING
5	UB1525	LINER NUT

COOLING METHOD	Water-Cooled
DUTY CYCLE - CO2	100% @ 500A
DUTY CYCLE - MIXED GAS	100% @ 450A
WIRE SIZE	0.8-1.6mm
LENGTHS (m)	3/4
STANDARD	EN60974-7
MINIMUM WATER FLOW	1.2L/min
MINIMUM WATER INLET PRESSURE	2.0 Bar
MINIMUM COOLING REQUIREMENTS	1200W
MAXIMUM WATER INLET PRESSURE	5.0 Bar
MAXIMUM WATER INLET TEMPERATURE	50°C

2.14 SB500 Water-Cooled BINZEL Style MIG Torch Consumables



Tip Holder

PCTH500	TIP HOLDER SUIT SB500 QTY 2
----------------	-----------------------------

Gas Diffuser

PCGD38	GAS DIFFUSER SUIT SB38 QTY 2
---------------	------------------------------

Contact Tip

PCTAL0005-08	CONTACT TIPS ALUMINIUM BINZEL STYLE M8 0.8MM QTY 10
PCTAL0005-09	CONTACT TIPS ALUMINIUM BINZEL STYLE M8 0.9MM QTY 10
PCTAL0005-10	CONTACT TIPS ALUMINIUM BINZEL STYLE M8 1.0MM QTY 10
PCTAL0005-12	CONTACT TIPS ALUMINIUM BINZEL STYLE M8 1.2MM QTY 10
PCTAL0005-16	CONTACT TIPS ALUMINIUM BINZEL STYLE M8 1.6MM QTY 10
PCT0005-08	CONTACT TIPS BINZEL STYLE M8 0.8MM QTY 10
PCT0005-09	CONTACT TIPS BINZEL STYLE M8 0.9MM QTY 10
PCT0005-10	CONTACT TIPS BINZEL STYLE M8 1.0MM QTY 10
PCT0005-12	CONTACT TIPS BINZEL STYLE M8 1.2MM QTY 10
PCT0005-16	CONTACT TIPS BINZEL STYLE M8 1.6MM QTY 10

Gas Nozzle

PGN38CYL	GAS NOZZLE CYLINDRICAL SUIT SB38 QTY 2
PGN38CON	GAS NOZZLE CONICAL SUIT SB38 QTY 2

Liners

SLB3M	LINER BINZEL STYLE STEEL BLUE 0.6-0.8MM 3M
SLB4M	LINER BINZEL STYLE STEEL BLUE 0.6-0.8MM 4M
SLB5M	LINER BINZEL STYLE STEEL BLUE 0.6-0.8MM 5M
SLR3M	LINER BINZEL STYLE STEEL RED 0.9-1.2MM 3M
SLR4M	LINER BINZEL STYLE STEEL RED 0.9-1.2MM 4M
SLR5M	LINER BINZEL STYLE STEEL RED 0.9-1.2MM 5M
SLY3M	LINER BINZEL STYLE STEEL YELLOW 1.2-1.6MM 3M
SLY4M	LINER BINZEL STYLE STEEL YELLOW 1.2-1.6MM 4M
SLY5M	LINER BINZEL STYLE STEEL YELLOW 1.2-1.6MM 5M
TLB3M	LINER BINZEL STYLE ALUMINIUM BLUE 0.6-0.8MM 3M
TLB4M	LINER BINZEL STYLE ALUMINIUM BLUE 0.6-0.8MM 4M
TLR3M	LINER BINZEL STYLE ALUMINIUM RED 0.9-1.2MM 3M
TLR4M	LINER BINZEL STYLE ALUMINIUM RED 0.9-1.2MM 4M
TLY3M	LINER BINZEL STYLE ALUMINIUM YELLOW 1.2-1.6MM 3M
TLY4M	LINER BINZEL STYLE ALUMINIUM YELLOW 1.2-1.6MM 4M
NKSTL-3.5MM	NECK SPRING FOR ALUMINIUM

2.15 M26 BINZEL Style Digital MIG Torch

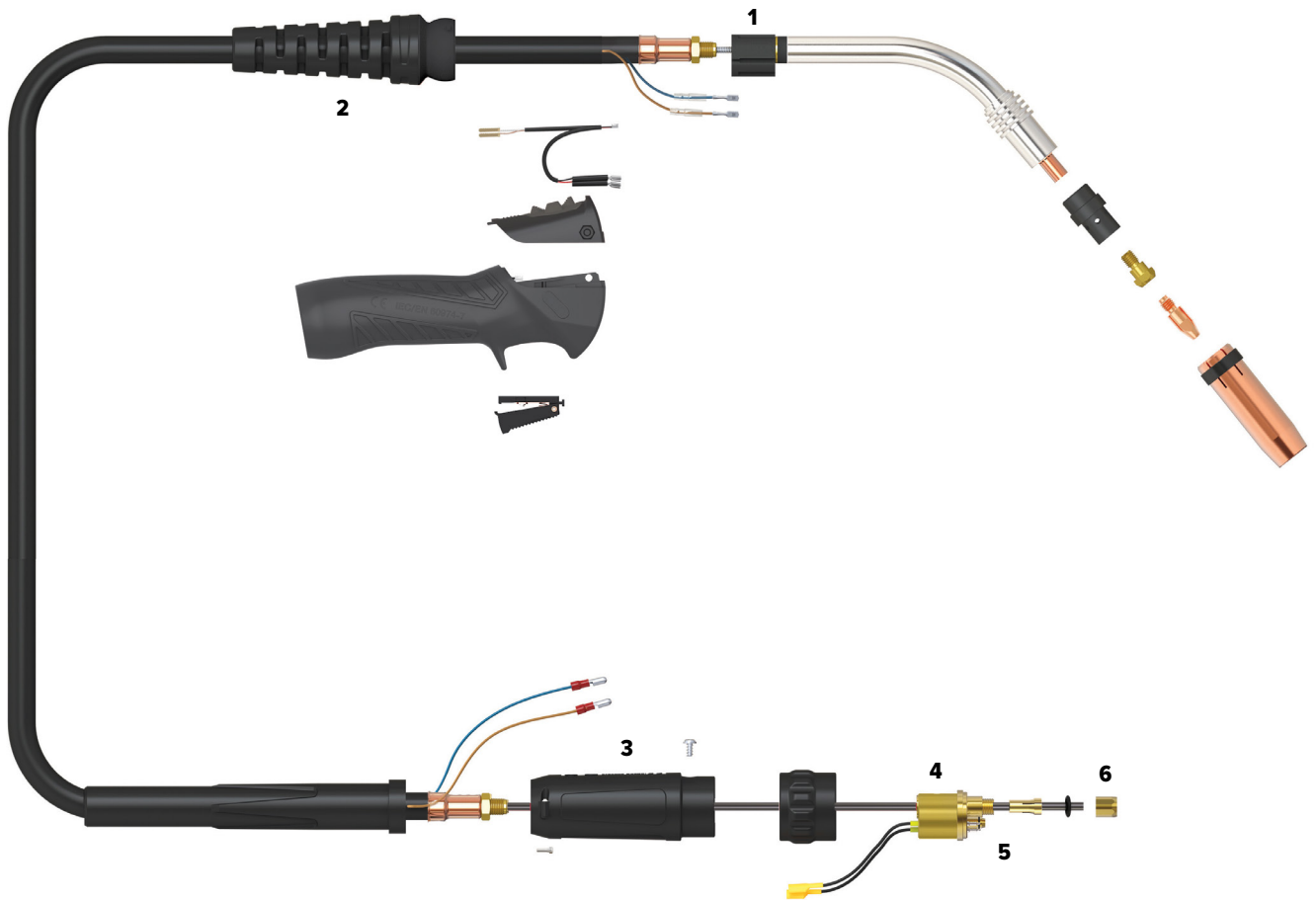

Length	3m	4m
SKU	U11194	U11195

1	UG1515	ERGO HANDLE LOCATION BODY
2	UEVG8016-BK	LARGE SUPPORT A/C WITH BALL JOINT
3	SC2578-L	GUN PLUG HOUSING
4	UB1528	GUN PLUG BODY C/W SPRING PINS
5	UB1524	GUN PLUG 'O' RING
6	UB1525	LINER NUT

COOLING METHOD	Air-Cooled
DUTY CYCLE - CO2	60% @ 270A
DUTY CYCLE - MIXED GAS	60% @ 240A
WIRE SIZE	0.8-1.2mm
STANDARD	EN60974-7

2.16 M26 BINZEL Style Digital MIG Torch Consumables



Gas Diffuser

PCGD26	GAS DIFFUSER SUIT SB38 QTY 2
U11184	GAS DIFFUSER PLASTIC SUIT DM26 QTY2

Tip Holder

PCTH26M8S	TIP HOLDER SUIT DM26 QTY 2
------------------	----------------------------

Contact Tip

PCTAL0005-08	CONTACT TIPS ALUMINIUM BINZEL STYLE M8 0.8MM QTY 10
PCTAL0005-09	CONTACT TIPS ALUMINIUM BINZEL STYLE M8 0.9MM QTY 10
PCTAL0005-10	CONTACT TIPS ALUMINIUM BINZEL STYLE M8 1.0MM QTY 10
PCTAL0005-12	CONTACT TIPS ALUMINIUM BINZEL STYLE M8 1.2MM QTY 10
PCTAL0005-16	CONTACT TIPS ALUMINIUM BINZEL STYLE M8 1.6MM QTY 10
PCT0005-08	CONTACT TIPS BINZEL STYLE M8 0.8MM QTY 10
PCT0005-09	CONTACT TIPS BINZEL STYLE M8 0.9MM QTY 10
PCT0005-10	CONTACT TIPS BINZEL STYLE M8 1.0MM QTY 10
PCT0005-12	CONTACT TIPS BINZEL STYLE M8 1.2MM QTY 10

Gas Nozzle

PGN38CYL	GAS NOZZLE CYLINDRICAL SUIT SB38 QTY 2
PGN38CON	GAS NOZZLE CONICAL SUIT SB38 QTY 2

Liners

U41001	LINER BINZEL STYLE ALL-PURPOSE 0.8-1.2MM 3M
SLB3M	LINER BINZEL STYLE STEEL BLUE 0.6-0.8MM 3M
SLB4M	LINER BINZEL STYLE STEEL BLUE 0.6-0.8MM 4M
SLB5M	LINER BINZEL STYLE STEEL BLUE 0.6-0.8MM 5M
SLR3M	LINER BINZEL STYLE STEEL RED 0.9-1.2MM 3M
SLR4M	LINER BINZEL STYLE STEEL RED 0.9-1.2MM 4M
SLR5M	LINER BINZEL STYLE STEEL RED 0.9-1.2MM 5M
TLB3M	LINER BINZEL STYLE ALUMINIUM BLUE 0.6-0.8MM 3M
TLB4M	LINER BINZEL STYLE ALUMINIUM BLUE 0.6-0.8MM 4M
TLR3M	LINER BINZEL STYLE ALUMINIUM RED 0.9-1.2MM 3M
TLR4M	LINER BINZEL STYLE ALUMINIUM RED 0.9-1.2MM 4M
NKSTL-3.5MM	NECK SPRING FOR ALUMINIUM



2.17 TWC2 Tweco Style MIG Torch

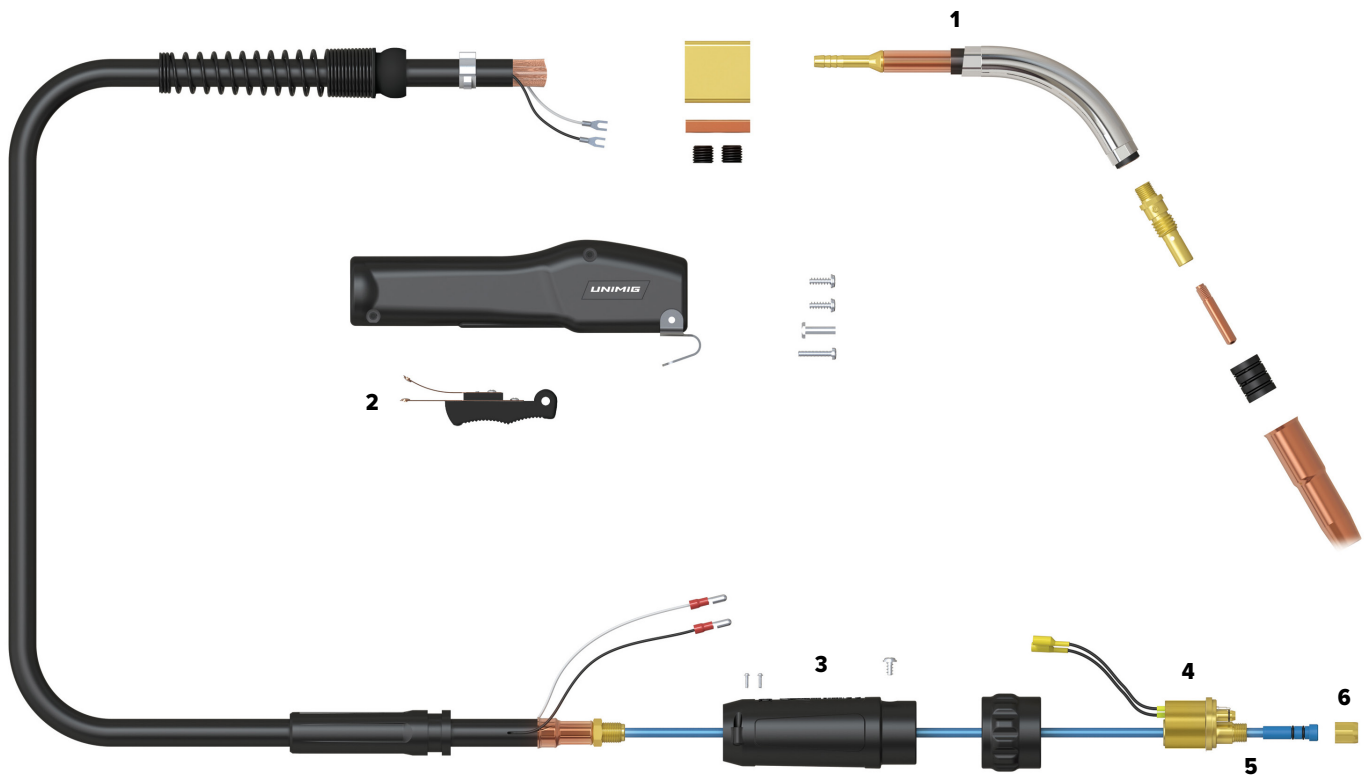

Length	12ft	15ft
SKU	TWC2-12FTE	TWC2-15FTE

1	WGA62A-45	SWAN NECK SUIT TWC2 45 DEGREE
	WGA62A-60	SWAN NECK SUIT TWC2 60 DEGREE
2	92	TRIGGER SWITCH
3	SC2578-S	GUN PLUG HOUSING
4	U174EX-1	TWC EURO GUN PLUG BODY
5	UB1524	GUN PLUG 'O' RING
6	UXL1826	LINER RETAINING NUT

COOLING METHOD	Air-Cooled
DUTY CYCLE - CO2	60% @ 200A
DUTY CYCLE - MIXED GAS	60% @ 150A
WIRE SIZE	0.6-1.2mm
STANDARD	EN60974-7

2.18 TWC2 Tweco Style MIG Torch Consumables

2.18.1 Adjustable Nozzle



Gas Diffuser

PWGA52	GAS DIFFUSER ADJUSTABLE SUIT TWC2 QTY 2
---------------	---

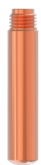

Contact Tip

PWGA14AH364	CONTACT TIPS HEAVY DUTY ALUMINIUM SUIT TWC2/4 1.2MM QTY 10
PWGA14AH116	CONTACT TIPS HEAVY DUTY ALUMINIUM SUIT TWC2/4 1.6MM QTY 10
PWGA14H30	CONTACT TIPS HEAVY DUTY SUIT TWC2/4 0.8MM QTY 10
PWGA14H35	CONTACT TIPS HEAVY DUTY SUIT TWC2/4 0.9MM QTY 10
PWGA14H40	CONTACT TIPS HEAVY DUTY SUIT TWC2/4 1.0MM QTY 10
PWGA14H45	CONTACT TIPS HEAVY DUTY SUIT TWC2/4 1.2MM QTY 10
PWGA14H52	CONTACT TIPS HEAVY DUTY SUIT TWC2/4 1.3MM FLUX-CORED QTY 10
PWGA1430	CONTACT TIPS SUIT TWC2/4 0.8MM QTY 10
PWGA1435	CONTACT TIPS SUIT TWC2/4 0.9MM QTY 10
PWGA1440	CONTACT TIPS SUIT TWC2/4 1.0MM QTY 10
PWGA1445	CONTACT TIPS SUIT TWC2/4 1.2MM QTY 10



Insulator

PWGA34A	INSULATOR ADJUSTABLE SUIT TWC4 QTY 2
----------------	--------------------------------------



Gas Nozzle

PWGA24A50	GAS NOZZLE ADJUSTABLE SUIT TWC4 13MM QTY 2
PWGA24A62	GAS NOZZLE ADJUSTABLE SUIT TWC4 16MM QTY 2



Liners

WGA44N-3545-15	LINER ALUMINIUM GREY 0.9-1.2MM SUIT TWC4/5 15FT
WGA44N-116-15	LINER ALUMINIUM GREY 1.6MM SUIT TWC4/5 15FT
WGA44-564-15	LINER STEEL GREEN 2.0MM SUIT TWC4/5 15FT
WGA44-3545-15	LINER STEEL RED 0.9-1.2MM SUIT TWC4/5 15FT
WGA44-116-15	LINER STEEL YELLOW 1.6MM SUIT TWC4/5 15FT

2.18.2 Fixed Nozzle



Gas Diffuser

PWGA52FN	GAS DIFFUSER FIXED SUIT TWC2 FOR PWGA34CT QTY 2
-----------------	---

Contact Tip

PWGA14AH364	CONTACT TIPS HEAVY DUTY ALUMINIUM SUIT TWC2/4 1.2MM QTY 10
PWGA14AH116	CONTACT TIPS HEAVY DUTY ALUMINIUM SUIT TWC2/4 1.6MM QTY 10
PWGA14H30	CONTACT TIPS HEAVY DUTY SUIT TWC2/4 0.8MM QTY 10
PWGA14H35	CONTACT TIPS HEAVY DUTY SUIT TWC2/4 0.9MM QTY 10
PWGA14H40	CONTACT TIPS HEAVY DUTY SUIT TWC2/4 1.0MM QTY 10
PWGA14H45	CONTACT TIPS HEAVY DUTY SUIT TWC2/4 1.2MM QTY 10
PWGA14H52	CONTACT TIPS HEAVY DUTY SUIT TWC2/4 1.3MM FLUX-CORED QTY 10
PWGA14H116	CONTACT TIPS HEAVY DUTY SUIT TWC4 1.6MM QTY 10
PWGA14H564	CONTACT TIPS HEAVY DUTY SUIT TWC4 2.0MM QTY 10
PWGA1430	CONTACT TIPS SUIT TWC2/4 0.8MM QTY 10
PWGA1435	CONTACT TIPS SUIT TWC2/4 0.9MM QTY 10
PWGA1440	CONTACT TIPS SUIT TWC2/4 1.0MM QTY 10
PWGA1445	CONTACT TIPS SUIT TWC2/4 1.22MM QTY 10

Insulator

PWGA34CT	INSULATOR FIXED SUIT TWC2/4 QTY 2
-----------------	-----------------------------------

Gas Nozzle

PWGA2350	GAS NOZZLE FIXED SUIT TWC2 13MM QTY 2
PWGA2362	GAS NOZZLE FIXED SUIT TWC2 16MM QTY 2
PWGA24CT50S	GAS NOZZLE FIXED SUIT TWC2/4 13MM QTY 2
PWGA24CT62S	GAS NOZZLE FIXED SUIT TWC2/4 16MM QTY 2

Liners

WGA44N-3545-15	LINER ALUMINIUM GREY 0.9-1.2MM SUIT TWC4/5 15FT
WGA44N-116-15	LINER ALUMINIUM GREY 1.6MM SUIT TWC4/5 15FT
WGA44-564-15	LINER STEEL GREEN 2.0MM SUIT TWC4/5 15FT
WGA44-3545-15	LINER STEEL RED 0.9-1.2MM SUIT TWC4/5 15FT
WGA44-116-15	LINER STEEL YELLOW 1.6MM SUIT TWC4/5 15FT

2.19 TWC4 Tweco Style MIG Torch

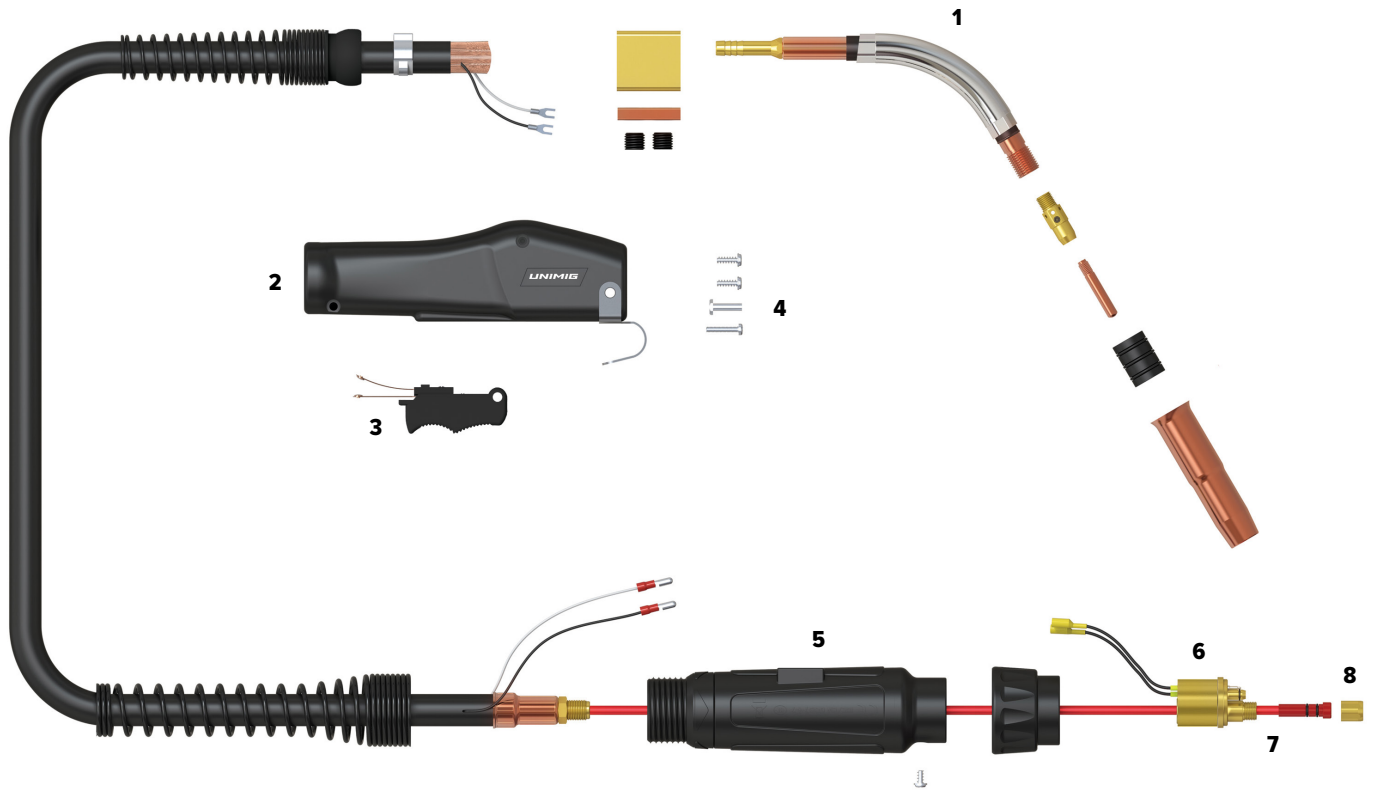

Length	12ft	15ft
SKU	TWC4-12FTE	TWC4-15FTE

1	U64J60	METAL JACKET NECK ASSEMBLY
	WGA64A-45	SWAN NECK SUIT TWC4 45 DEGREE
	WGA64A-60	SWAN NECK SUIT TWC4 60 DEGREE
2	UP84A	HANDLE WITH HOOK & SCREW
3	94R	TRIGGER ASSEMBLY
4	U124FMS	SCREW KIT
5	UT5022	GUN PLUG HOUSING ASSEMBLY
6	U174EX-1	TWC EURO GUN PLUG BODY
7	UB1524	GUN PLUG 'O' RING
8	UXL1826	LINER RETAINING NUT

COOLING METHOD	Air-Cooled
DUTY CYCLE - CO2	60% @ 400A
DUTY CYCLE - MIXED GAS	60% @ 350A
WIRE SIZE	0.8-2.0mm
STANDARD	EN60974-7

2.20 TWC4 Tweco Style MIG Torch Consumables

2.20.1 Adjustable Nozzle



Gas Diffuser

PWGA54A	GAS DIFFUSER SUIT TWC4 QTY 2
----------------	------------------------------



Contact Tip

PWGA14AH364	CONTACT TIPS HEAVY DUTY ALUMINIUM SUIT TWC2/4 1.2MM QTY 10
PWGA14AH116	CONTACT TIPS HEAVY DUTY ALUMINIUM SUIT TWC2/4 1.6MM QTY 10
PWGA14H30	CONTACT TIPS HEAVY DUTY SUIT TWC2/4 0.8MM QTY 10
PWGA14H35	CONTACT TIPS HEAVY DUTY SUIT TWC2/4 0.9MM QTY 10
PWGA14H40	CONTACT TIPS HEAVY DUTY SUIT TWC2/4 1.0MM QTY 10
PWGA14H45	CONTACT TIPS HEAVY DUTY SUIT TWC2/4 1.2MM QTY 10
PWGA14H52	CONTACT TIPS HEAVY DUTY SUIT TWC2/4 1.3MM FLUX-CORED QTY 10
PWGA14H116	CONTACT TIPS HEAVY DUTY SUIT TWC4 1.6MM QTY 10
PWGA14H564	CONTACT TIPS HEAVY DUTY SUIT TWC4 2.0MM QTY 10
PWGA1430	CONTACT TIPS SUIT TWC2/4 0.8MM QTY 10
PWGA1435	CONTACT TIPS SUIT TWC2/4 0.9MM QTY 10
PWGA1440	CONTACT TIPS SUIT TWC2/4 1.0MM QTY 10
PWGA1445	CONTACT TIPS SUIT TWC2/4 1.2MM QTY 10



Insulator

PWGA34A	INSULATOR ADJUSTABLE SUIT TWC4 QTY 2
----------------	--------------------------------------



Gas Nozzle

PWGA24A50	GAS NOZZLE ADJUSTABLE SUIT TWC4 13MM QTY 2
PWGA24A62	GAS NOZZLE ADJUSTABLE SUIT TWC4 16MM QTY 2



Liners

WGA44N-3545-15	LINER ALUMINIUM GREY 0.9-1.2MM SUIT TWC4/5 15FT
WGA44N-116-15	LINER ALUMINIUM GREY 1.6MM SUIT TWC4/5 15FT
WGA44-564-15	LINER STEEL GREEN 2.0MM SUIT TWC4/5 15FT
WGA44-3545-15	LINER STEEL RED 0.9-1.2MM SUIT TWC4/5 15FT
WGA44-116-15	LINER STEEL YELLOW 1.6MM SUIT TWC4/5 15FT
NKSTL-3.5MM	NECK SPRING FOR ALUMINIUM

2.20.2 Fixed Nozzle



Gas Diffuser

PWGA54A	GAS DIFFUSER SUIT TWC4 QTY 2
----------------	------------------------------

Contact Tip

PWGA14AH364	CONTACT TIPS HEAVY DUTY ALUMINIUM SUIT TWC2/4 1.2MM QTY 10
PWGA14AH116	CONTACT TIPS HEAVY DUTY ALUMINIUM SUIT TWC2/4 1.6MM QTY 10
PWGA14H30	CONTACT TIPS HEAVY DUTY SUIT TWC2/4 0.8MM QTY 10
PWGA14H35	CONTACT TIPS HEAVY DUTY SUIT TWC2/4 0.9MM QTY 10
PWGA14H40	CONTACT TIPS HEAVY DUTY SUIT TWC2/4 1.0MM QTY 10
PWGA14H45	CONTACT TIPS HEAVY DUTY SUIT TWC2/4 1.2MM QTY 10
PWGA14H52	CONTACT TIPS HEAVY DUTY SUIT TWC2/4 1.3MM FLUX-CORED QTY 10
PWGA14H116	CONTACT TIPS HEAVY DUTY SUIT TWC4 1.6MM QTY 10
PWGA14H564	CONTACT TIPS HEAVY DUTY SUIT TWC4 2.0MM QTY 10
PWGA1430	CONTACT TIPS SUIT TWC2/4 0.8MM QTY 10
PWGA1435	CONTACT TIPS SUIT TWC2/4 0.9MM QTY 10
PWGA1440	CONTACT TIPS SUIT TWC2/4 1.0MM QTY 10
PWGA1445	CONTACT TIPS SUIT TWC2/4 1.22MM QTY 10

Insulator

PWGA34CT	INSULATOR FIXED SUIT TWC2/4 QTY 2
-----------------	-----------------------------------

Gas Nozzle

PWGA24CT50S	GAS NOZZLE FIXED SUIT TWC2/4 13MM QTY 2
PWGA24CT62S	GAS NOZZLE FIXED SUIT TWC2/4 16MM QTY 2

Liners

WGA44N-3545-15	LINER ALUMINIUM GREY 0.9-1.2MM SUIT TWC4/5 15FT
WGA44N-116-15	LINER ALUMINIUM GREY 1.6MM SUIT TWC4/5 15FT
WGA44-564-15	LINER STEEL GREEN 2.0MM SUIT TWC4/5 15FT
WGA44-3545-15	LINER STEEL RED 0.9-1.2MM SUIT TWC4/5 15FT
WGA44-116-15	LINER STEEL YELLOW 1.6MM SUIT TWC4/5 15FT
NKSTL-3.5MM	NECK SPRING FOR ALUMINIUM

2.21 TWC5 Tweco Style MIG Torch

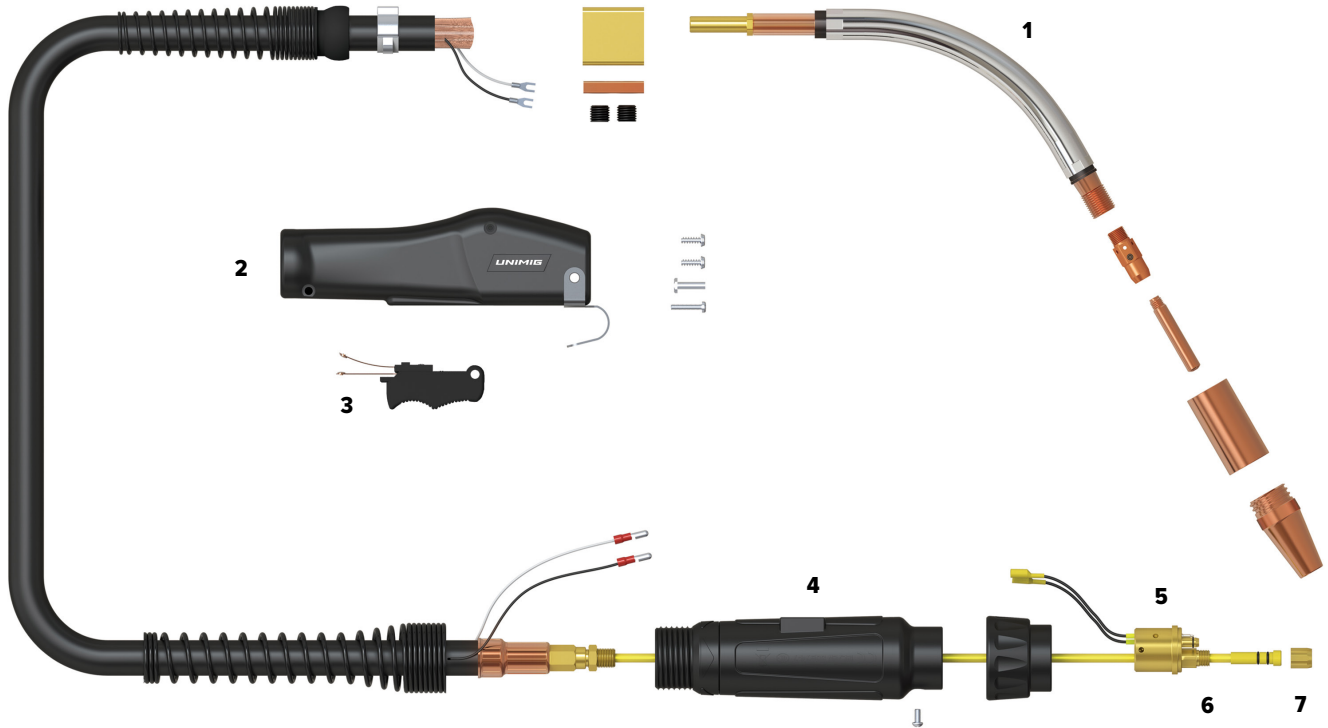

Length	12ft	15ft
SKU	TWC5-12FTE	TWC5-15FTE

1	WGA65A45	SWAN NECK SUIT TWC5 45 DEGREE
	WGA65A60	SWAN NECK HEAVY DUTY SUIT TWC5 45 DEGREE
	WGA65J45	SWAN NECK HEAVY DUTY SUIT TWC5 60 DEGREE
	WGA65J60	HEAVY DUTY SWAN NECK 60 DEGREE
2	UP85	HANDLE WITH HOOK & SCREW
3	94R	TRIGGER ASSEMBLY
4	UT5022	GUN PLUG HOUSING ASSEMBLY
5	U174EX-1	TWC EURO GUN PLUG BODY
6	UB1524	GUN PLUG O-RING
7	UXL1826	LINER RETAINING NUT

COOLING METHOD	Air-Cooled
DUTY CYCLE - CO2	60% @ 500A
DUTY CYCLE - MIXED GAS	60% @ 400A
WIRE SIZE	0.9-2.8mm
STANDARD	EN60974-7

2.22 TWC5 Tweco Style MIG Torch Consumables

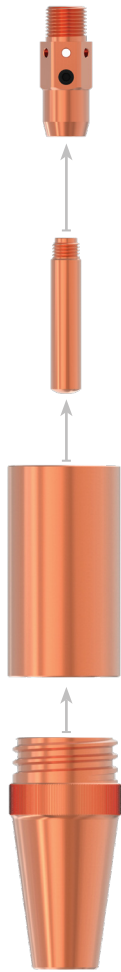

Tip Holder

PWGA55-SW	TIP HOLDER SUIT TWC5 0.9-1.2MM QTY 2
PWGA55	TIP HOLDER SUIT TWC5 1.6-2.0MM QTY 2
PWGA55-H	TIP HOLDER SUIT TWC5 2.4-2.8MM QTY 2

Contact Tip

PWGA15AH116	CONTACT TIPS HEAVY DUTY ALUMINIUM SUIT TWC5 1.6MM QTY 10
PWGA15H35	CONTACT TIPS HEAVY DUTY SUIT TWC5 0.9MM QTY 10
PWGA15H40	CONTACT TIPS HEAVY DUTY SUIT TWC5 1.0MM QTY 10
PWGA15H45	CONTACT TIPS HEAVY DUTY SUIT TWC5 1.2MM QTY 10
PWGA15H116	CONTACT TIPS HEAVY DUTY SUIT TWC5 1.6MM QTY 10
PWGA15H564	CONTACT TIPS HEAVY DUTY SUIT TWC5 2.0MM QTY 10

Insulator

PWGA35CT	INSULATOR FIXED SUIT TWC5 QTY 2
-----------------	---------------------------------

Gas Nozzle

PWGA25CT62	GAS NOZZLE FIXED SUIT TWC5 16MM QTY 2
PWGA25CT75	GAS NOZZLE FIXED SUIT TWC5 20MM QTY 2



Liners

WGA44N-3545-15	LINER ALUMINIUM GREY 0.9-1.2MM SUIT TWC4/5 15FT
WGA44N-116-15	LINER ALUMINIUM GREY 1.6MM SUIT TWC4/5 15FT
WGA44-564-15	LINER STEEL GREEN 2.0MM SUIT TWC4/5 15FT
WGA44-3545-15	LINER STEEL RED 0.9-1.2MM SUIT TWC4/5 15FT
WGA44-116-15	LINER STEEL YELLOW 1.6MM SUIT TWC4/5 15FT
NKSTL-3.5MM	NECK SPRING FOR ALUMINIUM

2.23 BND300 Bernard Style MIG Torch

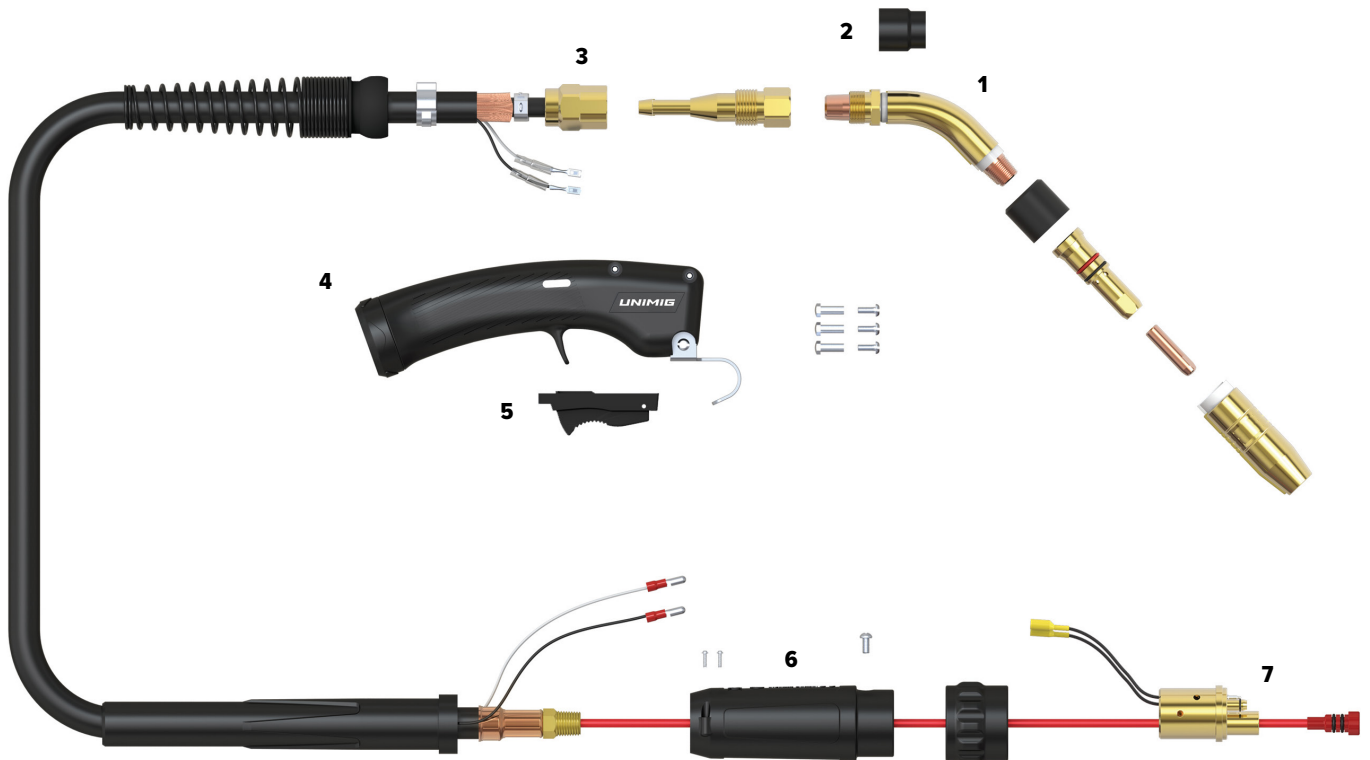

Length	12ft	15ft
SKU	ARBND300-12E	ARBND300-15E

1	WGA4786	SWAN NECK SUIT BND300	COOLING METHOD	Air-Cooled
2	U4780	NECK INSULATOR	DUTY CYCLE - CO2	60% @ 300A
3	UR4305	CONE NUT	DUTY CYCLE - MIXED GAS	60% @ 200A
4	UN1780006	HANDLE KIT C/W SCREWS & NUT	WIRE SIZE	0.8-1.2mm
5	U5662-BK	TRIGGER SWITCH	STANDARD	EN60974-7
6	SC2578-L	GUN PLUG HOUSING		
7	UB1524	GUN PLUG 'O' RING		

2.24 BND300 Bernard Style MIG Torch Consumables

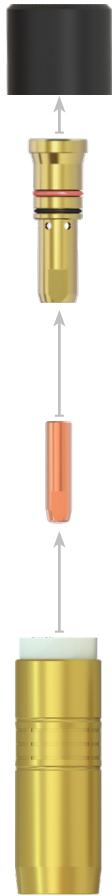

Rubber Cap

PWGA4323	RUBBER CAP BERNARD STYLE QTY 1
-----------------	--------------------------------

Head Assembly

PWGA4335	HEAD ASSEMBLY BERNARD STYLE SUIT BND300 QTY 2
PWGA4235	LONG HEAD ASSEMBLY LONG BERNARD STYLE SUIT BND300 QTY 2

Contact Tip

PWGA7498	CONTACT TIPS ALUMINIUM BERNARD STYLE 1.2MM QTY 10
PWGA7488	CONTACT TIPS BERNARD STYLE 0.8MM QTY 10
PWGA7489	CONTACT TIPS BERNARD STYLE 0.9MM QTY 10
PWGA7496	CONTACT TIPS BERNARD STYLE 1.0MM QTY 10
PWGA7490	CONTACT TIPS BERNARD STYLE 1.2MM QTY 10
PWGA1598	CONTACT TIPS LONG ALUMINIUM BERNARD STYLE 1.2MM QTY 10
PWGA1589	CONTACT TIPS LONG BERNARD STYLE 0.9MM QTY 10
PWGA1596	CONTACT TIPS LONG BERNARD STYLE 1.0MM QTY 10
PWGA1590	CONTACT TIPS LONG BERNARD STYLE 1.2MM QTY 10

Gas Nozzle

PWGA4391	GAS NOZZLE BERNARD STYLE CONICAL SUIT BND300 QTY 2
PWGA4392	GAS NOZZLE BERNARD STYLE TAPERED SUIT BND300 QTY 2
PWGA4395A	GAS NOZZLE BERNARD STYLE PIPELINE SUIT BND300 QTY 2

Liners

WGA43115X	LINER ALUMINIUM 0.8-1.2MM SUIT BND300 15FT
WGA43115	LINER STEEL 0.8-1.2MM SUIT BND300 15FT
WGA43215	LINER STEEL 1.2-1.6MM SUIT BND300 15FT

2.25 BND400 Bernard Style MIG Torch

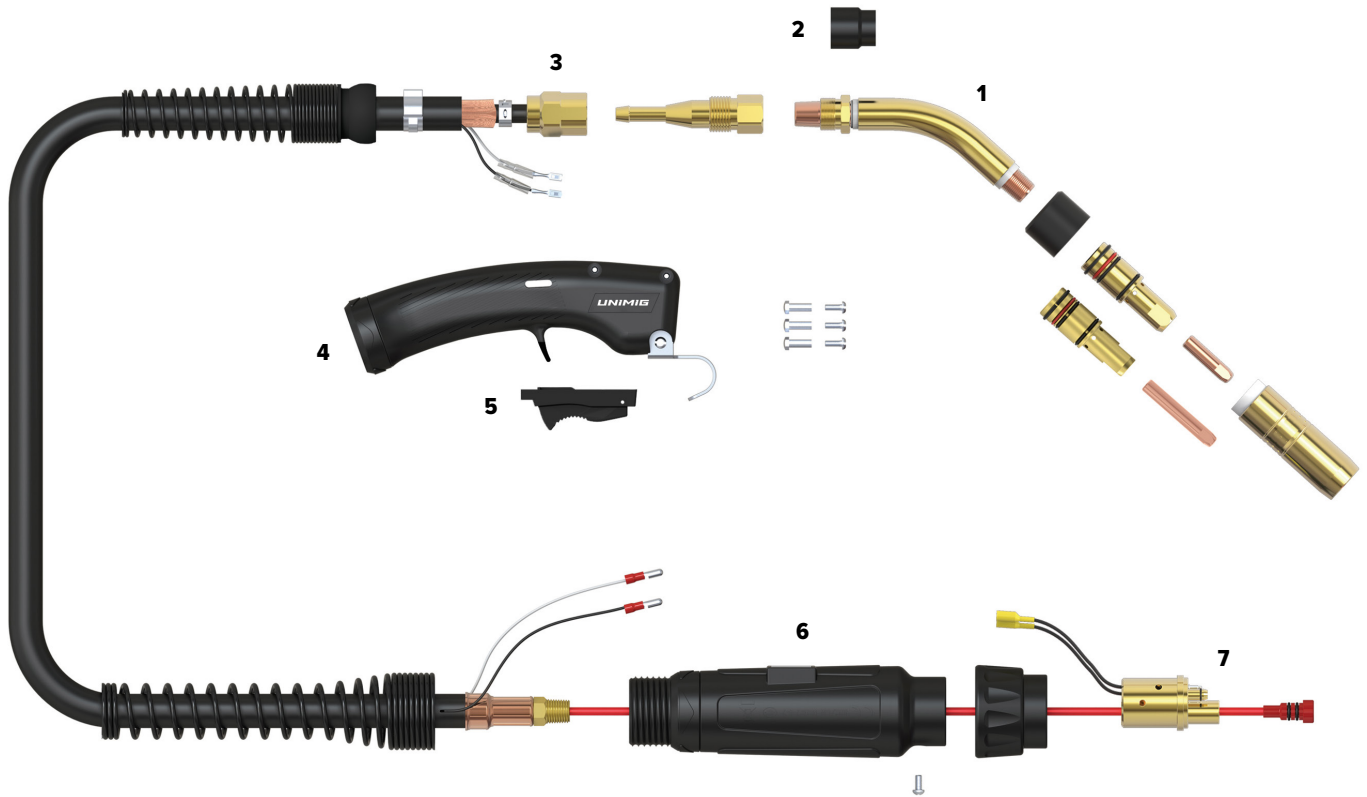

Length	12ft	15ft
SKU	ARBND400-12E	ARBND400-15E

1	WGA4790	SWAN NECK SUIT BND400
2	U4780	NECK INSULATOR
3	UR4305	CONE NUT
4	UN1780006	HANDLE KIT C/W SCREWS & NUT
5	U5662-BK	TRIGGER SWITCH
6	UT5022	GUN PLUG HOUSING ASSEMBLY
7	UB1524	GUN PLUG 'O' RING

COOLING METHOD	Air-Cooled
DUTY CYCLE - CO2	60% @ 400A
DUTY CYCLE - MIXED GAS	60% @ 320A
WIRE SIZE	0.8-1.6mm
STANDARD	EN60974-7

2.26 BND400 Bernard Style MIG Torch Consumables

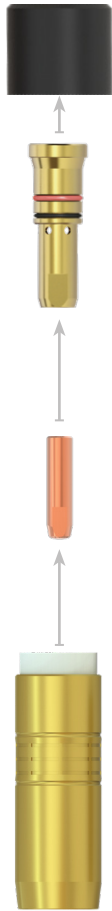

Rubber Cap

PWGA4323	RUBBER CAP BERNARD STYLE QTY 1
-----------------	--------------------------------

Head Assembly

PWGA4435	HEAD ASSEMBLY BERNARD STYLE SUIT BND400 QTY 2
PWGA4635	HEAD ASSEMBLY LONG BERNARD STYLE SUIT BDN400 QTY 2

Contact Tip

PWGA7498	CONTACT TIPS ALUMINIUM BERNARD STYLE 1.2MM QTY 10
PWGA7488	CONTACT TIPS BERNARD STYLE 0.8MM QTY 10
PWGA7489	CONTACT TIPS BERNARD STYLE 0.9MM QTY 10
PWGA7496	CONTACT TIPS BERNARD STYLE 1.0MM QTY 10
PWGA7490	CONTACT TIPS BERNARD STYLE 1.2MM QTY 10
PWGA1598	CONTACT TIPS LONG ALUMINIUM BERNARD STYLE 1.2MM QTY 10
PWGA1589	CONTACT TIPS LONG BERNARD STYLE 0.9MM QTY 10
PWGA1596	CONTACT TIPS LONG BERNARD STYLE 1.0MM QTY 10
PWGA1590	CONTACT TIPS LONG BERNARD STYLE 1.2MM QTY 10

Gas Nozzle

PWGA4491	GAS NOZZLE BERNARD STYLE CONICAL SUIT BND400 QTY 2
PWGA4492	GAS NOZZLE BERNARD STYLE TAPERED SUIT BND400 QTY 2



Liners

WGA43115X	LINER ALUMINIUM 1.2-1.6MM SUIT BND400 15FT
WGA43115	LINER STEEL 0.8-1.2MM SUIT BND400 15FT
WGA43215	LINER STEEL 1.2-1.6MM SUIT BND400 15FT

A large area of the page is filled with horizontal dotted lines, providing a template for handwritten notes or technical drawings.

UNIMIG



100%
AUSTRALIAN
OWNED

unimig.com.au

f @ UNIMIG